

RAIL 2 RM2D

LED . RECESSED DRYWALL . DIRECT



PART #:	
PREP BY:	DATE:
PROJECT:	
NOTES:	
APPROVAL SIGNATURE:	DATE (DD/MM/YYYY):

PERFORMANCE SUMMARY @ 3500K

		Meta Blanc (MB)	Meta Ice (M)	Drop Lens (MD)
		L3	L3	L3
Lumens per foot	80 CRI	595	671	624
	90 CRI	521	587	546
Wattage per foot		6.0		
Efficacy (lm/W)	80 CRI	98	111	103
	90 CRI	87	98	91
L70 Estimate (h)		≥ 60,000 hrs		

See page 2 for the complete Light Level Performance chart.

FEATURES

- 3/4" drop lens with seamless lines of light without pixels or shadows
- Integral drivers
- Option for daylight harvesting, occupancy sensing, dimming control and emergency lighting
- Optional Illuminated by BIOS version for Healthy Lighting and Well Building Applications

ORDERING LOGIC

Example Part Number: RM2D-1L35K-12-MB-W-L31-D-1-DW-90

RM2D													D
1	2	3	4	5	6	7	8	9	10	11	12	13	
1. SERIES RM2D	2. COLOR TEMP 1L30K 3000K 1L35K 3500K 1L40K 4000K		3. LENGTH 2 2 ft 3 3 ft 4 4 ft 5 5 ft 6 6 ft 7 7 ft 8 8 ft 9 9 ft 10 10 ft 11 11 ft 12 12 ft RA Continuous Rows Replace "A" with length in feet selected on p3 C Custom Length* - None (leave space empty)			4. PATTERN ¹ GA Square GAxB Rectangle UAxBxC U-Shape LAxB L-Shape C Custom Pattern* - None (leave space empty) Standard Patterns Minimal Lengths A = 4ft min, B = 4ft min. A = 3ft min, B = 4ft min, C = 3ft min. A = 3ft min, B = 3ft min. Custom Patterns* Lengths and a drawing of custom pattern are required on page 3 T-Shape Cross/X Wall-To-Ceiling Replace "A", "B", "C" with length in feet. See minimum lengths below Select corner: <input type="checkbox"/> Outside 90° <input type="checkbox"/> Inside 90°				5. OPTICS MB Meta Blanc M Meta Ice MD Drop Lens ** Meta Blanc & Drop Lens: Opal diffuse lens Meta Ice: High output semi-diffuse lens		6. FINISH SA Satin Aluminum W White B Black C Custom Finish Specify RAL:	
7. LIGHT LEVEL / DRIVER L1³ L2 L3 Select Driver below. See Light Level Performance chart on p2.		8. CIRCUITRY 1 1 Circuit EM Emergency / Night Light B Emergency Battery Pack ²		9. MOUNTING D Recessed Drywall Flanged		10. VOLTAGE 1 120V 2 277V 3 347V (Consult factory) 4 UNV(120-277V)		11. SENSORS		12. CONTROLS		13. OPTIONS 90 90 CRI, High R9 BS BIOS Static BD BIOS Dynamic - None (leave space empty)	
Please see last page for fixture integrated SENSORS and CONTROLS Order Logic codes													

*Consult factory. | ** Drop lens is not available with patterns. | ¹ Pattern approval drawings showing mounting locations will be sent out upon order. | ² Battery operates 4ft sections only. | ³ Not available with BIOS.

Select Driver:

- Factory option 0-10V, 1% Dimming
- LHE** Lutron H-Series Hi-lume 1% EcoSystem LED Driver
- LA2** Lutron A-Series Hi-lume 1% 2-wire LED Driver
- L5E** Lutron 5-Series EcoSystem LED Driver

Light Level Performance

3500K, 80 CRI, 0-10V Dimming (Standard)

Optics	Meta Blanc (MB)			Meta Ice (M)			Drop Lens (MD)		
	Lumens per foot	Wattage per foot	Efficacy (lm/W)	Lumens per foot	Wattage per foot	Efficacy (lm/W)	Lumens per foot	Wattage per foot	Efficacy (lm/W)
L1	350	3.5	101	408	3.5	118	367	3.5	104
L2	438	4.4	99	503	4.4	114	459	4.4	103
L3	595	6.0	98	671	6.0	111	624	6.0	103

Lumen Adjustment Factor (Standard)

Color Temp	80 CRI	90 CRI
3000K	0.984	0.880
3500K	1.000	0.875
4000K	1.032	0.879

BIOS 3500K

Distribution % (Up/Down)		Meta Blanc (MB)			Meta Ice (M)			Drop Lens (MD)		
		Lumens per foot	Wattage per foot	Efficacy (lm/W)	Lumens per foot	Wattage per foot	Efficacy (lm/W)	Lumens per foot	Wattage per foot	Efficacy (lm/W)
		0 / 100			0 / 100			6 / 94		
Static	L2	582	9.4	62	646	9.4	69	640	9.4	68
	L3	775	13.3	58	861	13.3	65	853	13.3	64
Dynamic	L2	523	9.4	55	582	9.4	62	576	9.4	61
	L3	697	13.3	52	775	13.3	58	768	13.3	58
R9		≥ 90								
COI**		< 3.3								
EML or M/P*		0.8								

BIOS | Lumen Adjustment Factor (LAF)

Color Temp	LAF
3500K	1.00
4000K	1.05

BIOS Naming Convention Reference

BIOS Static	3500K	35BIOSST
	4000K	40BIOSST
BIOS Dynamic	3500K	35BIOSDY
	4000K	40BIOSDY

* EML or M/P is a ratio that describes the relative melanopic lux (M) versus the photopic lux (P). BIOS provides the following m/p values: 3000K = 0.7, 3500K = 0.8, 4000K = 0.9. ** COI - Cyanosis Observation Index.

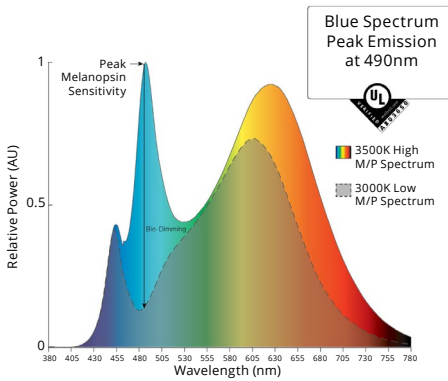

Metalumen's light level performance metrics are subject to manufacturers component tolerances.



CONTINUOUS ROWS

Step 1) Indicate desired quantity of rows under the QTY column

Step 2)  If applicable, select pod(s) per row to indicate desired emergency lighting / night light / battery location. If a similar row requires a different Emergency lighting location, please fill out another sheet.

Record drawings for rows not represented here will be sent out upon order.

LEGEND

-  Standard Wire Entry Location
(located on the end cap)
-  Emergency (EM) / Night Light Location
(4 ft sections)
-  EM or Battery Wire Entry Location
(EM wire entry is on the end cap)

A
 A = Run Length (Body)

EM / Night Light and EM or Battery Wire Entry location in relation to pod selections:
 Example 20 ft run

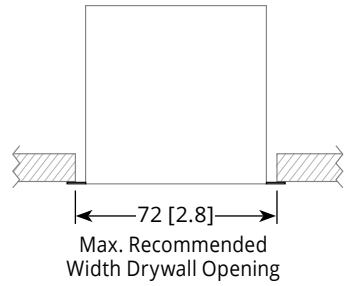

QTY	Nominal Length	Run Length Overall	Max. Recommended Length Drywall Opening (Max. Rec. Width = 72 mm)	Along / Start Length	Mid Length(s)	End Length	Visual Representation
							ROWS IN PLAN VIEW Rows are for demonstration purposes only and are not to scale.
	4'	1248 [49.1]	1237 [48.7]	4			1227 [48.3]
	8'	2465 [97.0]	2454 [96.6]	8			2444 [96.2]
	12'	3682 [145.0]	3671 [144.5]	12			3661 [144.1]
	16'	4906 [193.1]	4896 [192.8]	8	8		4885 [192.3]
	20'	6123 [241.1]	6113 [240.7]	12	8		6102 [240.2]
	24'	7340 [289.0]	7330 [288.6]	12		12	7319 [288.1]
	28'	8555 [336.8]	8545 [336.4]	8	12	8	8534 [336.0]
	32'	9763 [384.4]	9752 [383.9]	12	8	12	9742 [383.5]
	36'	10989 [432.6]	10979 [432.2]	12	12	12	10968 [431.8]
	40'	12185 [479.7]	12175 [479.3]	12	8, 8	12	12164 [487.9]
	44'	13411 [528.0]	13401 [527.6]	12	12, 8	12	13390 [527.2]
	48'	14637 [576.3]	14627 [575.9]	12	12, 12	12	14616 [575.4]

WIRING

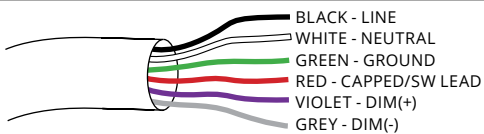
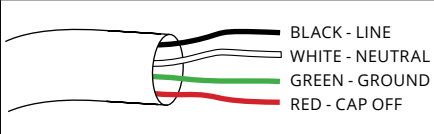
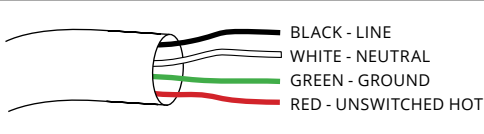
Standard Wiring	Emergency Wiring	Emergency Battery Pack Wiring
 <p>BLACK - LINE WHITE - NEUTRAL GREEN - GROUND RED - CAPPED/SW LEAD VIOLET - DIM(+) GREY - DIM(-)</p>	 <p>BLACK - LINE WHITE - NEUTRAL GREEN - GROUND RED - CAP OFF</p>	 <p>BLACK - LINE WHITE - NEUTRAL GREEN - GROUND RED - UNSWITCHED HOT</p>

CROSS SECTIONS

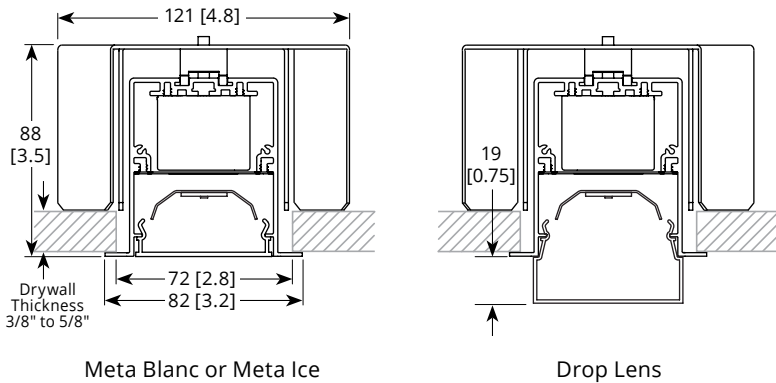

SPECIFICATIONS

Due to the Continuous Improvement Policy at Metalumen, we reserve the right to change our specifications without notice.

Housing: Rigid extruded aluminum body, 2.0mm (0.08”) nominal wall thickness. Aluminum end caps.
Optical System: Metalumen luminaires are designed to utilize leading edge LED technology combined with luminaire optimized reflectors and our custom diffusers, resulting in industry leading optical performance.
BIOS LED: BIOS SkyBlue® solutions have a peak wavelength at 490nm to provide an enhanced spectrum with high M/P (melanopic to photopic)

ratios while also providing a low Cyanosis Observation Index (COI), making it ideally suited for Healthcare and Healthy Lighting projects. BIOS® SkyBlue® lighting solutions also contribute to satisfying Circadian Lighting Design Feature for WELL Building Standard v1 and v2. BIOS is not suitable for insulated ceilings.
CRI: 83+ for 3500K, 80 minimum for all CCTs in standard configurations.
Lumen Maintenance: Minimum 50,000h with TM-21 lumen maintenance of 85% @ 25°C ambient

temperature (calculated based on IESNA LM-80-08 LED test data). L70: ≥60,000hrs.
Finish: Satin aluminum, white and black are standard finishes. For custom finish, contact factory.
Weight: 0.95 kg/300mm [2.1 lb/ft]
Mounting: Mounting brackets/clips provided.
Electrical: Factory prewired with easy wire quick connect sections.
Drivers: Metalumen offers 0-10V dimming* as a standard on our entire LED product offering. Dimming range is

1%-100%. Power factor is > 90%. Class 2 rating. Drivers are integral.
Approvals: All components are UL/ CSA/QPS recognized or listed. RoHS compliant. This product is cULus listed.
Environment: Suitable for dry or damp locations.

**Standard drivers compatible with passive/ sinking dimmers. Please contact Metalumen if active/sourcing dimmer support is required.*

WARRANTY

Metalumen will warrant defective luminaires for 5 years from date of purchase. Warranty is valid if luminaire is installed and used according to specification. If defective, Metalumen will send replacement boards or drivers at no cost along with detailed replacement instructions and instructions on how to return defective components to Metalumen.

PHOTOMETRIC DATA - 3500K, 80 CRI

Optics: Meta Blanc
IES File: RM2D-1L35K-4-MB-L3
Lumens: 595/ft Wattage: 6.1/ft
Efficacy: 98 lm/W

PHOTOMETRIC CURVE
100% Down

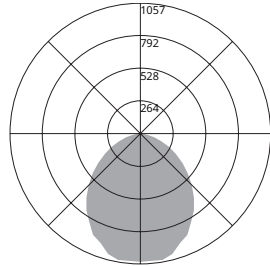

ZONAL LUMEN SUMMARY

Table with 3 columns: Zone, Lumens, %Fixt. Rows range from 0-20 to 0-180.

COEFFICIENTS OF UTILIZATION

Table with 3 columns: RC, RW, RCR. Rows range from 0 to 10.

LUMINANCE DATA (CD/M²)

Table with 2 columns: Vertical Angle, Horizontal Angle. Rows range from 45 to 85.

CANDELA DISTRIBUTION

Table with 2 columns: Vertical Angle, Horizontal Angle. Rows range from 0 to 90.

Optics: Meta Ice
IES File: RM2D-1L35K-4-M-L3
Lumens: 671/ft Wattage: 6.1/ft
Efficacy: 111 lm/W

PHOTOMETRIC CURVE
100% Down

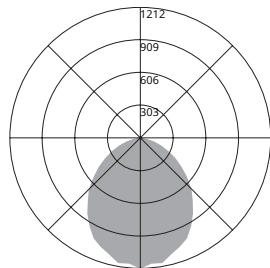

ZONAL LUMEN SUMMARY

Table with 3 columns: Zone, Lumens, %Fixt. Rows range from 0-20 to 0-180.

COEFFICIENTS OF UTILIZATION

Table with 3 columns: RC, RW, RCR. Rows range from 0 to 10.

LUMINANCE DATA (CD/M²)

Table with 2 columns: Vertical Angle, Horizontal Angle. Rows range from 45 to 85.

CANDELA DISTRIBUTION

Table with 2 columns: Vertical Angle, Horizontal Angle. Rows range from 0 to 90.

Optics: Drop Lens
IES File: RM2D-1L35K-4-MD-L3
Lumens: 624/ft Wattage: 6.1/ft
Efficacy: 103 lm/W

PHOTOMETRIC CURVE
6% Up
94% Down

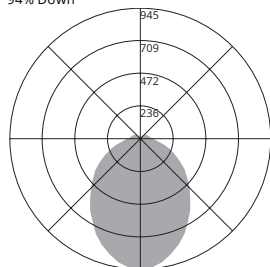

ZONAL LUMEN SUMMARY

Table with 3 columns: Zone, Lumens, %Fixt. Rows range from 0-20 to 0-180.

COEFFICIENTS OF UTILIZATION

Table with 3 columns: RC, RW, RCR. Rows range from 0 to 10.

LUMINANCE DATA (CD/M²)

Table with 2 columns: Vertical Angle, Horizontal Angle. Rows range from 45 to 85.

CANDELA DISTRIBUTION

Table with 2 columns: Vertical Angle, Horizontal Angle. Rows range from 0 to 90.

Photometric performance is measured and scaled in accordance with IESNA LM-79.

SENSORS AND CONTROLS



Metalumen offers intelligent standalone and/or connected luminaires with various integrated sensing and control system* connectivity options. The table below outlines some of the more common combinations and solutions offered. If you do not see the controls solution or the type of sensing technology you require for your project please contact us and we will work with you to try and identify a solution to meet your needs.

*Control system, installation and commissioning provided by others.

Examples:

WattStopper Daylight Sensor Standalone Luminaire: RM4D-1L35K-12-MB-W-L31-PA18-1-**DW**-90

Occupancy Sensor with Casambi Wireless Bluetooth Mesh Control Capability: RM4D-1L35K-12-MB-W-L31-PA18-1-**O-CAB**-90

ORDER LOGIC FIELDS		SENSOR FEATURE / BEHAVIOR		LUMINAIRE CONTROL / CONNECTIVITY	DESCRIPTION
11. SENSORS	12. CONTROLS	OCCUPANCY (PIR)	DAYLIGHT HARVESTING		
OF	-		None	Standalone	Factory Sensor - Occupancy Behaviors configured via BLE App
OW	-		None	Standalone (WattStopper)	Wattstopper Standalone Occupancy Sensor
DW	-	None		Standalone (WattStopper)	Wattstopper Standalone Daylight Harvesting Sensor
ODW	-			Standalone (WattStopper)	Wattstopper Standalone Occupancy and Daylight Harvesting Sensors
O	- CAB		None	Casambi Bluetooth Mesh	Casambi Bluetooth Mesh Connectivity with Occupancy Sensing
OD	- CAB			Casambi Bluetooth Mesh	Casambi Bluetooth Mesh Connectivity with Daylight Harvesting and Occupancy Sensing
	- CAB	None	None	Casambi Bluetooth Mesh	Casambi Bluetooth Mesh Connectivity (no sensors)
O	- SLVR		None	Silvair Bluetooth Mesh	Open Standard Bluetooth Mesh Connectivity with Occupancy Sensing
OD	- SLVR			Silvair Bluetooth Mesh	Open Standard Bluetooth Mesh Connectivity with Daylight Harvesting and Occupancy Sensing
	- SLVR	None	None	Silvair Bluetooth Mesh	Open Standard Bluetooth Mesh Connectivity (no sensors)
	- OSRM	None	None	Osram Enceium	Osram Enceium connectivity
OD	- OSRM			Osram Enceium	Osram SensiLum Connectivity for Enceium with Occupancy and Daylight Harvesting
OD	- ENL			Enlighted ONE	Occupancy and Daylight Harvesting Capable Supports EnlightedONE room control as well and upgrade path for Enlighted Connected and Enlighted IoT offering advanced applications, analytics and insights for Space Utilization/Optimization, Asset Tracking, Energy Monitoring, HVAC Integration etc..
	- DALI	None	None	DALI addressable wired Luminaire	Generic DALI addressable luminaire
	- ECOS	None	None	Lutron Ecosystem	Lutron Ecosystem addressable wired luminaire NOTE: See Driver Selection options for specific driver

