

RAIL 2 RM2D

LED . WALL . DIRECT

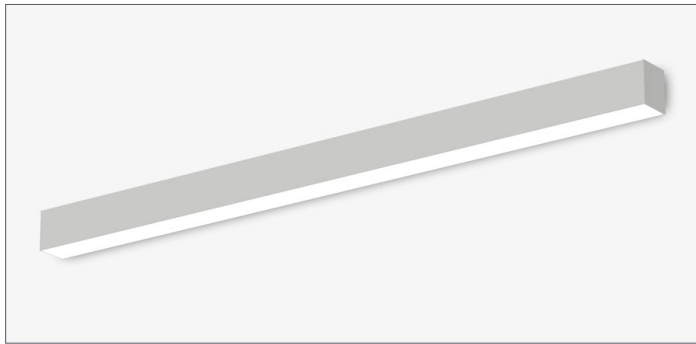

PART #:	
PREP BY:	DATE:
PROJECT:	
NOTES:	
APPROVAL SIGNATURE:	DATE (DD/MM/YYYY):

PERFORMANCE SUMMARY @ 3500K

		Meta Blanc (MB)	Meta Ice (M)	Drop Lens (MD)
		L3	L3	L3
Lumens per foot	80 CRI	595	671	624
	90 CRI	521	587	546
Wattage per foot		6.0		
Efficacy (lm/W)	80 CRI	98	111	103
	90 CRI	87	98	91
L70 Estimate (h)		≥ 60,000 hrs		

See page 2 for the complete Light Level Performance chart.

FEATURES

- 3/4" drop lens with seamless lines of light without pixels or shadows
- Integral drivers
- Option for daylight harvesting, occupancy sensing, dimming control and emergency lighting
- Optional Illuminated by BIOS version for Healthy Lighting and Well Building Applications

ORDERING LOGIC

Example Part Number: RM2D-1L35K-12-MB-W-L31-W-1-DW-90

RM2D											W	
1	2	3	4	5	6	7	8	9	10	11		
1. SERIES RM2D		2. COLOR TEMP 1L30K 3000K 1L35K 3500K 1L40K 4000K 90 CRI is available under OPTIONS BIOS is available under OPTIONS. See p2 for BIOS Naming Convention Reference			3. LENGTH 2 2 ft 3 3 ft 4 4 ft 5 5 ft 6 6 ft 7 7 ft 8 8 ft 9 9 ft 10 10 ft 11 11 ft 12 12 ft RA Continuous Rows Replace "A" with length in feet C Custom Length* - None (leave space empty)			4. OPTICS MB Meta Blanc M Meta Ice MD Drop Lens Meta Blanc & Drop Lens: Opal diffuse lens Meta Ice: High output semi-diffuse lens		5. FINISH SA Satin Aluminum W White B Black C Custom Finish Specify RAL:		
6. LIGHT LEVEL / DRIVER L1 ¹ L2 L3 L3 ¹		7. CIRCUITRY 1 1 Circuit EM Emergency / Night Light B Emergency Battery Pack ²			8. MOUNTING W Wall		9. VOLTAGE 1 120V 2 277V 3 347V (Consult Factory) 4 UNV (120-277V)		10. SENSORS		11. CONTROLS	12. OPTIONS 90 90 CRI, High R9 BS BIOS Static BD BIOS Dynamic - None (leave space empty)
Select Driver below. See Light Level Performance chart on p2.		Please see last page for fixture integrated SENSORS and CONTROLS Order Logic codes										

*Consult factory. | ¹Not available with BIOS. | ²Battery operates 4ft sections only.

Select Driver:

- Factory option 0-10V, 1% Dimming
- LHE** Lutron H-Series Hi-lume 1% EcoSystem LED Driver
- LA2** Lutron A-Series Hi-lume 1% 2-wire LED Driver
- L5E** Lutron 5-Series EcoSystem LED Driver

Light Level Performance

3500K, 80 CRI, 0-10V Dimming (Standard)

Optics	Meta Blanc (MB)			Meta Ice (M)			Drop Lens (MD)		
	Lumens per foot	Wattage per foot	Efficacy (lm/W)	Lumens per foot	Wattage per foot	Efficacy (lm/W)	Lumens per foot	Wattage per foot	Efficacy (lm/W)
L1	350	3.5	101	408	3.5	118	367	3.5	104
L2	438	4.4	99	503	4.4	114	459	4.4	103
L3	595	6.0	98	671	6.0	111	624	6.0	103
L4	828	9.1	91	927	9.1	102	868	9.1	96

Lumen Adjustment Factor (Standard)

Color Temp	80 CRI	90 CRI
3000K	0.984	0.880
3500K	1.000	0.875
4000K	1.032	0.879

BIOS 3500K

		Meta Blanc (MB)			Meta Ice (M)			Drop Lens (MD)		
		Lumens per foot	Wattage per foot	Efficacy (lm/W)	Lumens per foot	Wattage per foot	Efficacy (lm/W)	Lumens per foot	Wattage per foot	Efficacy (lm/W)
Distribution % (Up/Down)		0 / 100			0 / 100			6 / 94		
Static	L2	582	9.4	62	646	9.4	69	640	9.4	68
	L3	775	13.3	58	861	13.3	65	853	13.3	64
Dynamic	L2	523	9.4	55	582	9.4	62	576	9.4	61
	L3	697	13.3	52	775	13.3	58	768	13.3	58
R9		≥ 90								
COI**		< 3.3								
EML or M/P*		0.8								

BIOS | Lumen Adjustment Factor (LAF)

Color Temp	LAF
3500K	1.00
4000K	1.05

BIOS Naming Convention Reference

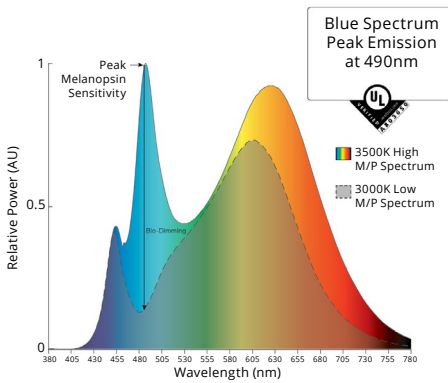

BIOS	Static	3500K	35BIOSST
		4000K	40BIOSST
BIOS	Dynamic	3500K	35BIOSDY
		4000K	40BIOSDY

* EML or M/P is a ratio that describes the relative melanopic lux (M) versus the photopic lux (P). BIOS provides the following m/p values: 3000K = 0.7, 3500K = 0.8, 4000K = 0.9. ** COI - Cyanosis Observation Index.

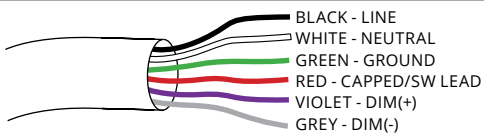
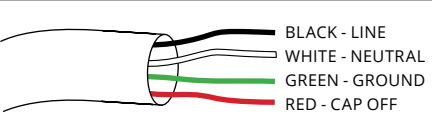

Metalumen's light level performance metrics are subject to manufacturers component tolerances.

WIRING

Standard Wiring	Emergency Wiring	Emergency Battery Pack Wiring
 <p>BLACK - LINE WHITE - NEUTRAL GREEN - GROUND RED - CAPPED/SW LEAD VIOLET - DIM(+) GREY - DIM(-)</p>	 <p>BLACK - LINE WHITE - NEUTRAL GREEN - GROUND RED - CAP OFF</p>	 <p>BLACK - LINE WHITE - NEUTRAL GREEN - GROUND RED - UNSWITCHED HOT</p>

CROSS SECTIONS

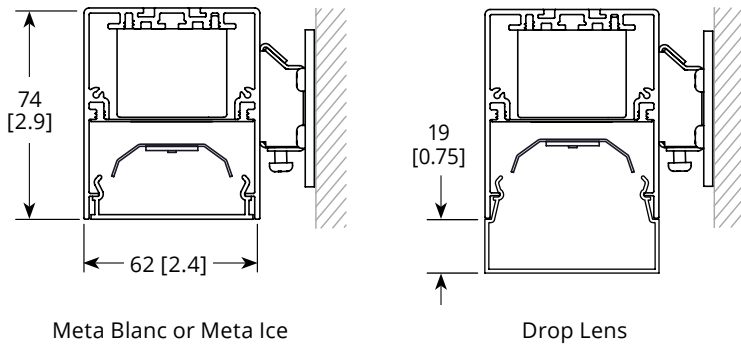

SPECIFICATIONS

Due to the Continuous Improvement Policy at Metalumen, we reserve the right to change our specifications without notice.

Housing: Rigid extruded aluminum body, 2.0mm (0.08”) nominal wall thickness. Aluminum end caps.

Optical System: Metalumen luminaires are designed to utilize leading edge LED technology combined with luminaire optimized reflectors and our custom diffusers, resulting in industry leading optical performance.

BIOS LED: BIOS SkyBlue® solutions have a peak wavelength at 490nm to provide an enhanced spectrum with high M/P (melanopic to photopic)

ratios while also providing a low Cyanosis Observation Index (COI), making it ideally suited for Healthcare and Healthy Lighting projects. BIOS® SkyBlue® lighting solutions also contribute to satisfying Circadian Lighting Design Feature for WELL Building Standard v1 and v2.

CRI: 83+ for 3500K, 80 minimum for all CCTs in standard configurations.
Lumen Maintenance: Minimum 50,000h with TM-21 lumen maintenance of 85% @ 25°C ambient temperature (calculated based on

IESNA LM-80-08 LED test data). L70: ≥60,000hrs.

Finish: Satin aluminum, white and black are standard finishes. For custom finish, contact factory.

Weight: 0.95 kg/300mm [2.1 lb/ft]

Mounting: Mounting plate provided.

Electrical: Factory prewired with easy wire quick connect sections.

Drivers: Metalumen offers 0-10V dimming as a standard on our entire LED product offering. Dimming range is 1%-100%. Power factor is > 90%. Class 2 rating. Drivers are integral.

Approvals: All components are UL/ CSA/QPS recognized or listed. RoHS compliant. This product is cULus listed.
Environment: Suitable for dry or damp locations.

**Standard drivers compatible with passive/sinking dimmers. Please contact Metalumen if active/sourcing dimmer support is required.*

WARRANTY

Metalumen will warrant defective luminaires for 5 years from date of purchase. Warranty is valid if luminaire is installed and used according to specification. If defective, Metalumen will send replacement boards or drivers at no cost along with detailed replacement instructions and instructions on how to return defective components to Metalumen.

PHOTOMETRIC DATA - 3500K, 80 CRI

Optics: **Meta Blanc**
 IES File: **RM2D-1L35K-4-MB-L3**
 Lumens: **595/ft** Wattage: **6.1/ft**
 Efficacy: **98 lm/W**

PHOTOMETRIC CURVE
 100% Down

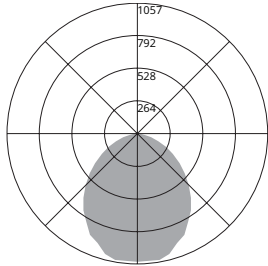

ZONAL LUMEN SUMMARY

Zone	Lumens	%Fixt
0-20	378	15.9
0-30	784	32.9
0-40	1241	52
0-60	2016	84.5
0-80	2358	98.8
0-90	2385	100
10-90	2286	95.8
20-40	863	36.2
20-50	1293	54.2
40-70	1005	42.1
60-80	342	14.3
70-80	112	4.7
80-90	27	1.2
90-110	0	0
90-120	0	0
90-130	0	0
90-150	0	0
90-180	0	0
110-180	0	0
0-180	2385	100

COEFFICIENTS OF UTILIZATION

Zonal Cavity Method | Effective Floor Cavity Reflectance = .20

RC	80				70				50			
	RW	70	50	30	10	70	50	30	10	50	30	10
RCR	0	119	119	119	119	116	116	116	116	111	111	111
1	110	105	102	98	107	103	100	97	99	96	93	
2	101	93	87	82	98	91	85	81	88	83	79	
3	92	83	75	69	90	81	74	68	78	72	67	
4	85	74	66	59	83	73	65	59	70	63	58	
5	79	66	58	52	77	65	57	51	63	56	51	
6	73	60	52	46	71	59	51	45	57	50	45	
7	68	55	46	41	66	54	46	40	53	45	40	
8	63	50	42	36	62	50	42	36	48	41	36	
9	59	46	38	33	58	46	38	33	45	38	33	
10	56	43	35	30	54	42	35	30	41	35	30	

CANDELA DISTRIBUTION

Vertical Angle	Horizontal Angle				
	0	22.5	45	67.5	90
0	1036	1036	1036	1036	1036
5	1031	1048	1057	1053	1028
10	1037	1032	1020	1026	1036
15	1006	990	990	994	980
20	941	938	947	936	936
25	903	893	882	872	866
30	823	835	807	797	794
35	757	751	733	713	707
40	678	664	649	620	610
45	589	589	558	533	524
50	501	496	470	441	428
55	418	410	384	356	348
60	330	329	306	287	276
65	258	248	232	212	205
70	183	177	161	150	144
75	117	114	101	93	90
80	62	60	55	49	48
85	24	23	20	19	19
90	6	5	4	5	4

LUMINANCE DATA (CD/M²)

Vertical Angle	Horizontal Angle		
	0	45	90
45	10388	5519	4452
55	8871	3893	2959
65	7139	2495	1791
75	4884	1188	836
85	2111	270	200

Optics: **Meta Ice**
 IES File: **RM2D-1L35K-4-M-L3**
 Lumens: **671/ft** Wattage: **6.1/ft**
 Efficacy: **111 lm/W**

PHOTOMETRIC CURVE
 100% Down

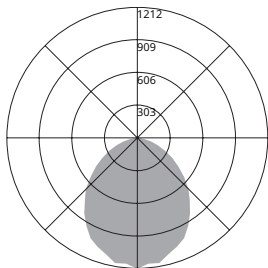

ZONAL LUMEN SUMMARY

Zone	Lumens	%Fixt
0-20	426	16
0-30	882	33
0-40	1397	52
0-60	2273	85
0-80	2658	99
0-90	2689	100
10-90	2577	96
20-40	971	36
20-50	1457	54
40-70	1135	42
60-80	385	14
70-80	126	5
80-90	31	1
90-110	0	0
90-120	0	0
90-130	0	0
90-150	0	0
90-180	0	0
110-180	0	0
0-180	2689	100

COEFFICIENTS OF UTILIZATION

Zonal Cavity Method | Effective Floor Cavity Reflectance = .20

RC	80				70				50			
	RW	70	50	30	10	70	50	30	10	50	30	10
RCR	0	119	119	119	119	116	116	116	116	111	111	111
1	110	105	102	98	107	103	100	97	99	96	93	
2	101	93	87	82	98	91	85	81	88	83	79	
3	92	83	75	69	90	81	74	68	78	72	67	
4	85	74	66	59	83	73	65	59	70	63	58	
5	79	66	58	52	77	65	57	51	63	56	51	
6	73	60	52	46	71	59	51	45	57	50	45	
7	68	55	46	41	66	54	46	40	53	45	40	
8	63	50	42	36	62	50	42	36	48	41	36	
9	59	46	38	33	58	46	38	33	45	38	33	
10	56	43	35	30	54	42	35	30	41	35	30	

CANDELA DISTRIBUTION

Vertical Angle	Horizontal Angle				
	0	22.5	45	67.5	90
0	1212	1212	1212	1212	1212
5	1171	1174	1171	1160	1185
10	1177	1159	1167	1154	1153
15	1118	1127	1118	1104	1111
20	1074	1066	1056	1046	1044
25	1026	1003	986	976	979
30	942	936	915	893	901
35	853	851	821	802	795
40	756	756	730	697	693
45	671	658	635	599	588
50	565	559	528	502	490
55	467	463	438	407	400
60	376	370	343	323	311
65	287	279	261	238	235
70	203	200	184	167	162
75	133	128	116	104	102
80	71	69	61	55	52
85	27	26	23	21	21
90	7	5	4	5	5

LUMINANCE DATA (CD/M²)

Vertical Angle	Horizontal Angle		
	0	45	90
45	11845	6275	4993
55	9920	4438	3396
65	7941	2807	2061
75	5544	1370	955
85	2386	307	215

Optics: **Drop Lens**
 IES File: **RM2D-1L35K-4-MD-L3**
 Lumens: **624/ft** Wattage: **6.1/ft**
 Efficacy: **103 lm/W**

PHOTOMETRIC CURVE
 6% Up
 94% Down

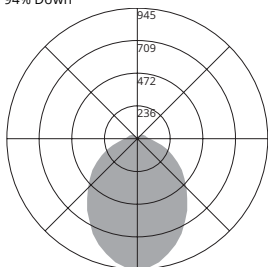

ZONAL LUMEN SUMMARY

Zone	Lumens	%Fixt
0-20	332	14
0-30	686	30
0-40	1086	47
0-60	1809	78
0-80	2220	96
0-90	2307	100
10-90	2219	96
20-40	754	33
20-50	1143	50
40-70	974	42
60-80	411	18
70-80	159	7
80-90	88	4
90-110	0	0
90-120	0	0
90-130	0	0
90-150	0	0
90-180	0	0
110-180	0	0
0-180	2307	100

COEFFICIENTS OF UTILIZATION

Zonal Cavity Method | Effective Floor Cavity Reflectance = .20

RC	80				70				50			
	RW	70	50	30	10	70	50	30	10	50	30	10
RCR	0	119	119	119	119	116	116	116	116	111	111	111
1	108	103	99	95	105	101	97	93	97	93	90	
2	99	90	83	77	96	88	82	77	85	79	75	
3	90	80	71	65	88	78	70	64	75	68	63	
4	83	71	62	55	80	69	61	55	67	60	54	
5	76	63	55	48	74	62	54	48	60	53	47	
6	71	57	49	42	69	56	48	42	55	47	42	
7	66	52	44	37	64	51	43	37	50	42	37	
8	61	48	39	34	60	47	39	33	46	38	33	
9	57	44	36	30	56	43	36	30	42	35	30	
10	54	41	33	28	53	40	33	28	39	32	27	

CANDELA DISTRIBUTION

Vertical Angle	Horizontal Angle				
	0	22.5	45	67.5	90
0	947	947	947	947	947
5	953	919	935	921	936
10	908	898	903	902	903
15	863	870	861	870	868
20	838	829	827	814	800
25	785	779	762	759	760
30	720	713	710	700	701
35	654	650	635	632	628
40	574	574	570	566	564
45	504	504	501	507	508
50	422	432	436	447	445
55	345	355	372	387	395
60	278	293	315	331	341
65	211	227	258	279	284
70	152	173	204	227	233
75	96	120	156	179	183
80	54	78	117	136	138
85	23	49	86	106	108
90	9	35	74	89	94

LUMINANCE DATA (CD/M²)

Vertical Angle	Horizontal Angle		
	0	45	90
45	8744	4403	3773
55	7153	3292	2875
65	5650	2366	2090
75	3801	1536	1402
85	1849	940	894

Photometric performance is measured and scaled in accordance with IESNA LM-79.

SENSORS AND CONTROLS



Metalumen offers intelligent standalone and/or connected luminaires with various integrated sensing and control system* connectivity options. The table below outlines some of the more common combinations and solutions offered. If you do not see the controls solution or the type of sensing technology you require for your project please contact us and we will work with you to try and identify a solution to meet your needs.

*Control system, installation and commissioning provided by others.

Examples:

WattStopper Daylight Sensor Standalone Luminaire: RM4D-1L35K-12-MB-W-L31-PA18-1-**DW**-90

Occupancy Sensor with Casambi Wireless Bluetooth Mesh Control Capability: RM4D-1L35K-12-MB-W-L31-PA18-1-**O-CAB**-90

ORDER LOGIC FIELDS		SENSOR FEATURE / BEHAVIOR		LUMINAIRE CONTROL / CONNECTIVITY	DESCRIPTION
11. SENSORS	12. CONTROLS	OCCUPANCY (PIR)	DAYLIGHT HARVESTING		
OF	-		None	Standalone	Factory Sensor - Occupancy Behaviors configured via BLE App
OW	-		None	Standalone (WattStopper)	Wattstopper Standalone Occupancy Sensor
DW	-	None		Standalone (WattStopper)	Wattstopper Standalone Daylight Harvesting Sensor
ODW	-			Standalone (WattStopper)	Wattstopper Standalone Occupancy and Daylight Harvesting Sensors
O	- CAB		None	Casambi Bluetooth Mesh	Casambi Bluetooth Mesh Connectivity with Occupancy Sensing
OD	- CAB			Casambi Bluetooth Mesh	Casambi Bluetooth Mesh Connectivity with Daylight Harvesting and Occupancy Sensing
	- CAB	None	None	Casambi Bluetooth Mesh	Casambi Bluetooth Mesh Connectivity (no sensors)
O	- SLVR		None	Silvair Bluetooth Mesh	Open Standard Bluetooth Mesh Connectivity with Occupancy Sensing
OD	- SLVR			Silvair Bluetooth Mesh	Open Standard Bluetooth Mesh Connectivity with Daylight Harvesting and Occupancy Sensing
	- SLVR	None	None	Silvair Bluetooth Mesh	Open Standard Bluetooth Mesh Connectivity (no sensors)
	- OSRM	None	None	Osram Enceium	Osram Enceium connectivity
OD	- OSRM			Osram Enceium	Osram SensiLum Connectivity for Enceium with Occupancy and Daylight Harvesting
OD	- ENL			Enlighted ONE	Occupancy and Daylight Harvesting Capable Supports EnlightedONE room control as well and upgrade path for Enlighted Connected and Enlighted IoT offering advanced applications, analytics and insights for Space Utilization/Optimization, Asset Tracking, Energy Monitoring, HVAC Integration etc..
	- DALI	None	None	DALI addressable wired Luminaire	Generic DALI addressable luminaire
	- ECOS	None	None	Lutron Ecosystem	Lutron Ecosystem addressable wired luminaire NOTE: See Driver Selection options for specific driver

