

RAIL 2 RM2D

TUNABLE . RECESSED DRYWALL FLANGELESS . DIRECT

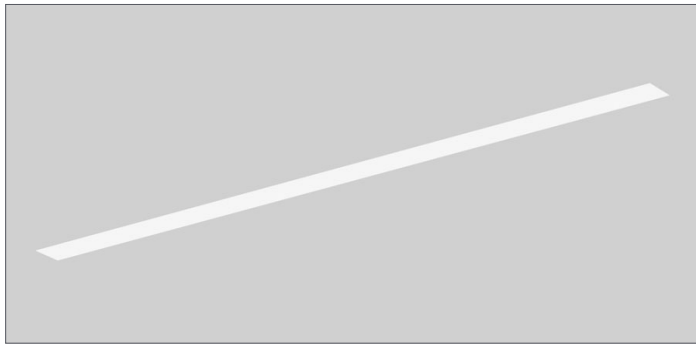

PART #:	
PREP BY:	DATE:
PROJECT:	
NOTES:	
APPROVAL SIGNATURE:	DATE (DD/MM/YYYY):

PERFORMANCE SUMMARY @ 4000K

		Meta Blanc (MB)	Drop Lens (MD)
		L3	L3
Lumens per foot	80 CRI	515	564
	90 CRI	452	496
Distribution (Up / Down %)		0 / 100	12 / 88
Wattage per foot		6.2	
Efficacy (lm/W)	80 CRI	82	91
	90 CRI	72	80
L70 Estimate (h)		> 60,000 hrs	

See page 2 for the complete Light Level Performance chart.

FEATURES

- Independant control of intensity and correlated color temperature (CCT)
- Allows for scheduled mimicking of daylight color temperatures
- Dim-to-Warm simulates warmer CCT shift as luminaire dims (i.e. like traditional incandescent and halogen lights).

ORDERING LOGIC

Example Part Number: RM2D-1LTUN-8-MB-W-L31-DF-1-D-90

RM2D						DF				
1	2	3	4	5	6	7	8	9	10	11
1. SERIES RM2D	2. COLOR TEMP 1LTUN Tunable White (2700 - 6500K) 1LDW Dim to Warm* (3500 - 2700K) 90 CRI is available under OPTIONS	3. LENGTH 2 2 ft 3 3 ft 4 4 ft 5 5 ft 6 6 ft 7 7 ft 8 8 ft 9 9 ft 10 10 ft 11 11 ft 12 12 ft	4. OPTICS MB Meta Blanc MD Drop Lens Meta Blanc & Drop Lens: Opal diffuse lens	5. FINISH SA Satin Aluminum W White B Black C Custom Finish Specify RAL:	6. LIGHT LEVEL / DRIVER L1 L2 L3 L4 <div style="border: 1px solid black; padding: 2px; width: fit-content;">Select Driver below. See Light Level Performance chart on p2.</div>	7. CIRCUITRY 1 1 Circuit EM Emergency / Night Light ¹ B Emergency Battery Pack ²	8. MOUNTING DF Recessed Drywall Flangeless	9. VOLTAGE 1 120 V 2 277 V 4 UNV (120 - 277V)	10. CONTROLS / SENSORS _ None (leave space empty) D Daylight Sensor** O Occupancy Sensor** DO Daylight and Occupany Sensors**	11. OPTIONS 90 90 CRI, High R9 _ None (leave space empty)

PLEASE NOTE	Dim to Warm is not available with integrated sensors. Tunable White and Dim to Warm are available with emergency battery packs connected to the cool color LEDs only.
-------------	--

* Consult factory for alternate options. | ** Controls intensity only (not CCT). | ¹ Each EM pod, by default, has separate wire entry for DIM and CCT control. | ² Battery operates 4ft sections only.

Select Driver:

- Factory option dual 0-10V (Dim & CCT), 1% Dimming
- Lutron T Series EcoSystem, 1% Dimming
- DALI - Factory Option, DT6 Dual Address, 1% Dimming
- DALI - Factory Option, DT8 Single Address Color Control, 1% Dimming
- DALI - EldoLED

Light Level Performance at 4000K

Meta Blanc (MB)		2700K				4000K				6500K			
		L1	L2	L3	L4	L1	L2	L3	L4	L1	L2	L3	L4
Total Lumens / foot (lm)	80 CRI	281	351	468	654	304	381	515	735	307	383	511	715
	90 CRI	247	309	412	575	267	335	452	646	269	337	449	629
Wattage per foot		3.9	4.8	6.5	9.8	3.8	4.7	6.2	9.1	3.9	4.9	6.6	10.0
Efficacy (lm/W)	80 CRI	72	73	72	67	78	81	82	81	78	79	77	71
	90 CRI	63	64	63	59	69	71	72	71	69	69	68	63
Color Rendering (CRI)		80+											
		90+											
L70 Estimate @ 25°C Ambient		> 60,000 hrs											

Drop Lens (MD)		2700K				4000K				6500K			
		L1	L2	L3	L4	L1	L2	L3	L4	L1	L2	L3	L4
Total Lumens / foot (lm)	80 CRI	308	385	514	727	333	418	564	817	337	421	561	796
	90 CRI	271	338	451	639	293	367	496	718	296	370	493	700
Wattage per foot		3.9	4.8	6.5	9.8	3.8	4.7	6.2	9.1	3.9	4.9	6.6	10.1
Efficacy (lm/W)	80 CRI	79	80	79	74	87	90	91	89	86	86	85	79
	90 CRI	70	70	70	65	76	79	80	78	75	76	74	70
Color Rendering (CRI)		80+											
		90+											
L70 Estimate @ 25°C Ambient		> 60,000 hrs											

Metalumen's light level performance metrics are subject to manufacturers component tolerances.

WIRING

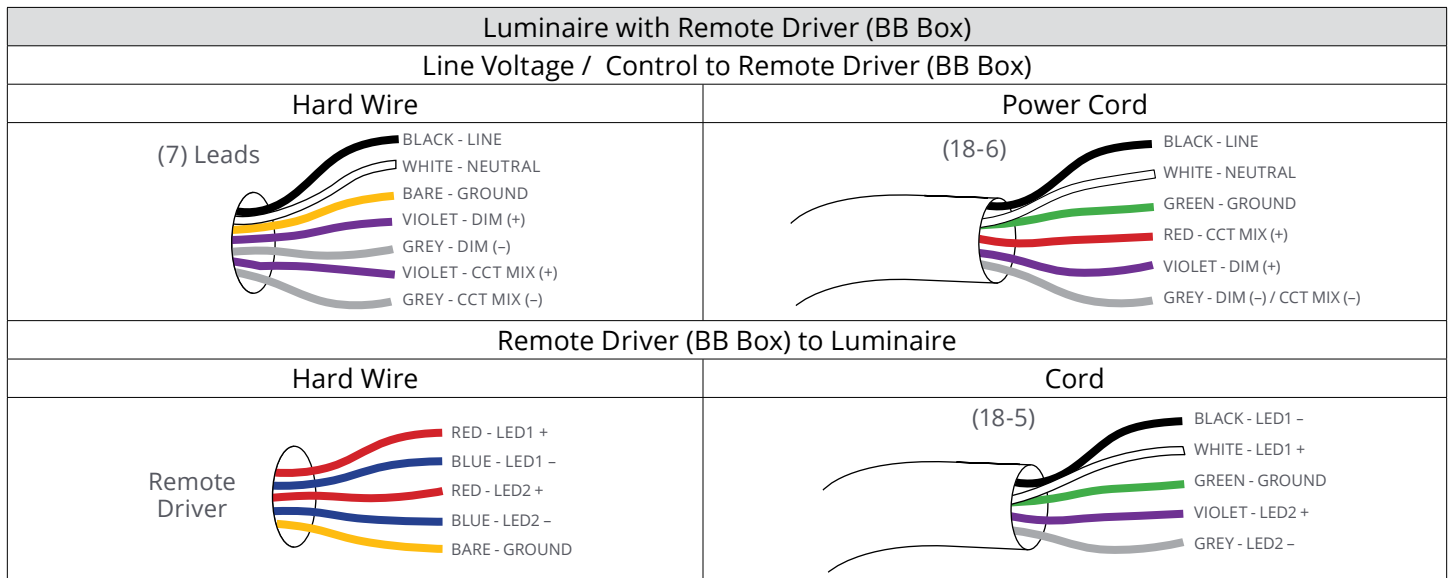
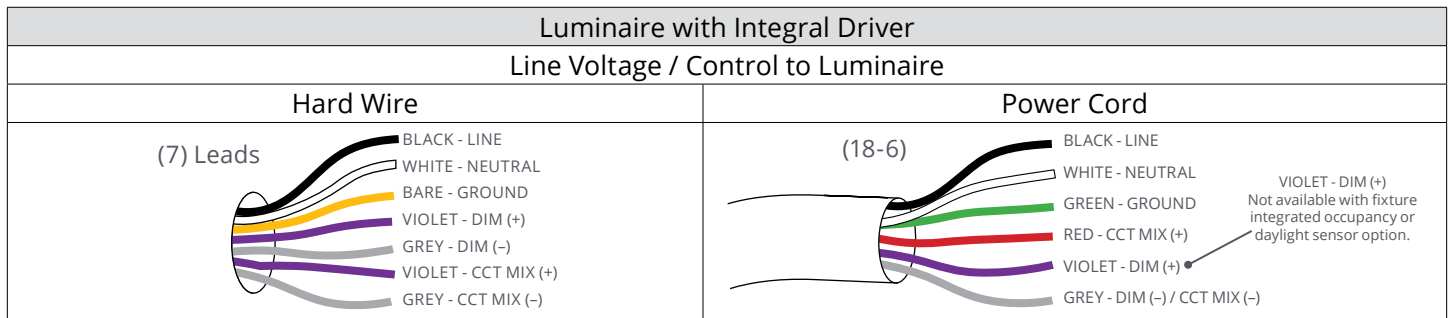
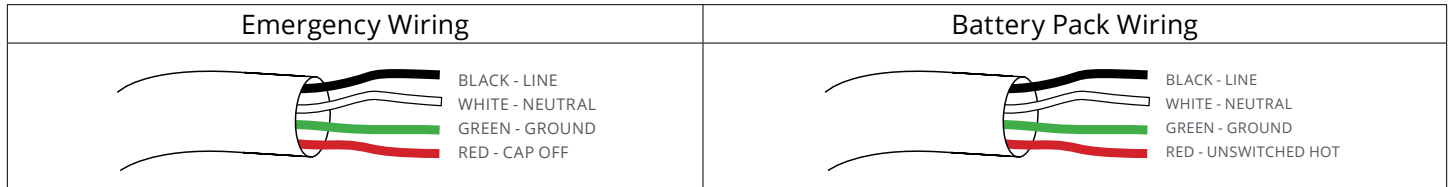

CONTINUOUS ROWS



Step 1) Indicate desired quantity of rows under the QTY column
 Step 2)  If applicable, select pod(s) per row to indicate desired emergency lighting / night light / battery location. If a similar row requires a different Emergency lighting location, please fill out another sheet.

Record drawings for rows not represented here will be sent out upon order.

QTY	Nominal Length	Max. Recommended Length Drywall Opening (Max. Rec. Width = 72 mm)	Along / Start Length	Mid Length(s)	End Length	ROWS IN PLAN VIEW
4'	1237 [48.7]	4				1227 [48.3]
8'	2454 [96.6]	8				2444 [96.2]
12'	3671 [144.5]	12				3661 [144.1]

Rows are for demonstration purposes only and are not to scale.

LEGEND

-  Standard Wire Entry Location (located on the end cap)
-  Emergency (EM) / Night Light Location (4 ft sections)
-  EM or Battery Wire Entry Location (EM wire entry is on the end cap)

A  A = Run Length (Body)

EM / Night Light and EM or Battery Wire Entry location in relation to pod selections:

Example 12 ft run



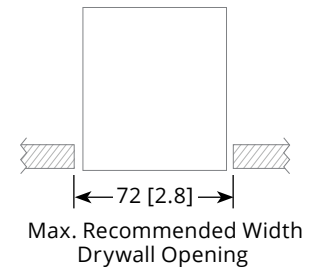

CROSS SECTIONS

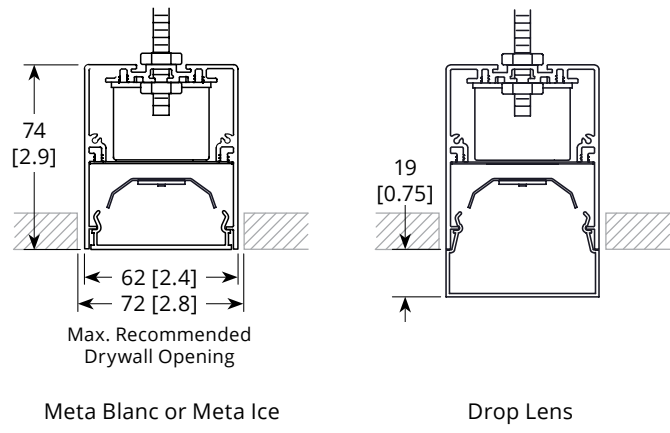

SPECIFICATIONS

Due to the Continuous Improvement Policy at Metalumen, we reserve the right to change our specifications without notice.

Housing: Rigid extruded aluminum body, 2.0mm (0.08") nominal wall thickness. Aluminum end caps.
Optical System: Metalumen luminaires are designed to utilize leading edge LED technology combined with luminaire optimized reflectors and our custom diffusers, resulting in industry leading optical performance.
CRI: 83+ for 3500K, 80 minimum for all

CCTs in standard configurations.
Lumen Maintenance: Minimum 50,000h with TM-21 lumen maintenance of 85% @ 25°C ambient temperature (calculated based on IESNA LM-80-08 LED test data). L70: ≥ 100,000hrs.
Finish: Satin aluminum, white and black are standard finishes. For custom finish, contact factory.
Weight: 0.95 kg/300mm [2.1 lb/ft]

Mounting: Mounting brackets provided.
Electrical: Factory prewired with easy wire quick connect sections.
Drivers: Metalumen offers 0-10V dimming* as a standard on our entire LED product offering. Dimming range is 1%-100%. Power factor is > 90%. Class 2 rating. Drivers are integral.
Approvals: All components are UL/ CSA/QPS recognized or listed. RoHS

compliant. This product is cULus listed.
Environment: Suitable for dry or damp locations.

**Standard drivers compatible with passive/ sinking dimmers. Please contact Metalumen if active/sourcing dimmer support is required*

WARRANTY

Metalumen will warrant defective luminaires for 5 years from date of purchase. Warranty is valid if luminaire is installed and used according to specification. If defective, Metalumen will send replacement boards or drivers at no cost along with detailed replacement instructions and instructions on how to return defective components to Metalumen.