

RAIL 4 RM4D

LED . RECESSED T-BAR . DIRECT



PART #:	
PREP BY:	DATE:
PROJECT:	
NOTES:	
APPROVAL SIGNATURE:	DATE (DD/MM/YYYY):

PERFORMANCE SUMMARY @ 3500K		Meta Blanc (MB)	Meta Ice (M)	Drop Lens (MD)
		L3	L3	L3
Lumens per foot	80 CRI	596	662	608
	90 CRI	522	579	532
Wattage per foot		6.1	6.1	6.1
Efficacy (lm/W)	80 CRI	99	109	100
	90 CRI	85	95	87
L70 Estimate (h)		≥ 60,000 hrs		

See page 2 for the complete Light Level Performance chart.

FEATURES

- Efficacy up to 111 lm/W
- Integral drivers
- Option for daylight harvesting, occupancy sensing, dimming control and emergency lighting

ORDERING LOGIC

Example Part Number: RM4D-1L35K-12-MB-W-L31-T-1-D-90

RM4D												
1	2	3	4	5	6	7	8	9	10	11	12	
1. SERIES RM4D	2. COLOR TEMP 1L30K 3000K 1L35K 3500K 1L40K 4000K CRI 90 is available under OPTIONS	3. LENGTH 2 2 ft 3 3 ft 4 4 ft 5 5 ft 6 6 ft 7 7 ft 8 8 ft 9 9 ft 10 10 ft 11 11 ft 12 12 ft RA Continuous Rows Replace "A" with length in feet selected on p2 C Custom Length* - None (leave space empty)			4. PATTERN ¹ GA Square GAxB Rectangle UAxBxC U-Shape LAxB L-Shape C Custom Pattern* _ None (leave space empty) Standard Patterns Minimum Lengths Square: A = 4 ft min. Rectangle: A = 4 ft min, B = 4 ft min. U-Shape: A = 3 ft min, B = 4 ft min, C = 3 ft min. L-Shape: A = 3 ft min, B = 3 ft min. Custom Patterns* Lengths and a drawing of custom pattern are required on page 3 T-Shape X / Cross Replace "A", "B", "C" with length in feet. See minimum lengths below Select corner: <input type="checkbox"/> Outside 90° <input type="checkbox"/> Inside 90° 				5. OPTICS MB Meta Blanc M Meta Ice MD Drop Lens** Meta Blanc & Drop Lens: Opal diffuse lens Meta Ice: High output semi-diffuse lens		6. FINISH SA Satin Aluminum W White B Black C Custom Finish Specify RAL:	
7. LIGHT LEVEL / DRIVER L1 Select Driver below. L2 See Light Level Performance chart on p2. L3 L4	8. CIRCUITRY 1 1 Circuit EM Emergency / Night Light B Emergency Battery Pack ²		9. MOUNTING T Recessed T-Bar		10. VOLTAGE 1 120 V 2 277 V 3 347 V 4 UNV (120 - 277V)		11. CONTROLS / SENSORS _ None (leave space empty) D Wattstopper Daylight Sensor O Wattstopper Occupancy Sensor DO Wattstopper Daylight and Occupancy Sensor		12. OPTIONS 90 90 CRI, High R9 P Plenum _ None (leave space empty)			

*Consult factory. | ** Drop lens is not available with patterns. | ¹ Pattern record drawings showing mounting locations will be sent out upon order. | ² Battery operates 4ft sections only.

Select Driver:

- Factory option 0-10V, 10% Dimming (Standard)
- Factory option 0-10V, 1% Dimming
- LHE Lutron H-Series Hi-lume 1% EcoSystem LED Driver
- LA2 Lutron A-Series Hi-lume 1% 2-wire LED Driver
- L5E Lutron 5-Series EcoSystem LED Driver

Light Level Performance | 3500K, 80 CRI, 0-10V Dimming (Standard)

Optics	Meta Blanc (MB)			Meta Ice (M)			Drop Lens (MD)		
	Lumens per foot	Wattage per foot	Efficacy (lm/W)	Lumens per foot	Wattage per foot	Efficacy (lm/W)	Lumens per foot	Wattage per foot	Efficacy (lm/W)
L1	350	3.5	100	389	3.5	111	357	3.5	102
L2	439	4.4	99	487	4.4	110	447	4.4	101
L3	596	6.1	99	662	6.1	109	608	6.0	100
L4	1106	12.5	89	1232	12.5	99	1127	12.5	90

Metalumen's light level performance metrics are subject to manufacturers component tolerances.

Lumen Adjustment Factor

Color Temp	80 CRI	90 CRI
3000K	0.984	0.880
3500K	1.000	0.875
4000K	1.032	0.879

CONTINUOUS ROWS

Step 1) Indicate desired quantity of rows under the QTY column

Step 2) ← Pods → If applicable, select pod(s) per row to indicate desired Emergency lighting location. If a similar row requires a different Emergency lighting location, please fill out another sheet.

Record drawings for rows not represented here will be sent out upon order.

QTY	Nominal Length	Run Length Overall	Along / Start Length	Mid Length(s)	End Length	ROWS IN PLAN VIEW	
						Rows are for demonstration purposes only and are not to scale.	
4'	For 4' T-bar Centers	4				1209 [47.6]	
8'	For 8' T-bar Centers	8				2428 [95.6]	
12'	For 12' T-bar Centers	12				3648 [143.6]	
16'	For 16' T-bar Centers	8		8		4867 [191.6]	
20'	For 20' T-bar Centers	12		8		6086 [238.9]	
24'	For 24' T-bar Centers	12		12		7305 [287.6]	
28'	For 28' T-bar Centers	8	12	8		8524 [335.6]	
32'	For 32' T-bar Centers	12	8	12		9744 [383.6]	
36'	For 36' T-bar Centers	12	12	12		10963 [431.6]	
40'	For 40' T-bar Centers	12	8, 8	12		12182 [479.6]	
44'	For 44' T-bar Centers	12	12, 8	12		13401 [527.6]	
48'	For 48' T-bar Centers	12	12, 12	12		14620 [575.6]	

LEGEND

- Standard (STD) Wire Entry Location (located on the end cap)
- Emergency (EM) / Night Light Location (4 ft sections)
- EM or Battery Wire Entry Location (EM wire entry is on the end cap)

A

A = Run Length (Body)

EM / Night Light and EM or Battery Wire Entry location in relation to pod selections:

Example 20 ft run

WIRING

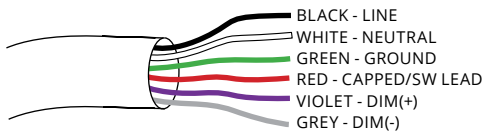
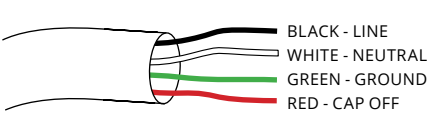
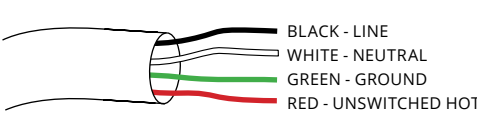
Standard Wiring	Emergency Wiring	Emergency Battery Pack Wiring
 <p>BLACK - LINE WHITE - NEUTRAL GREEN - GROUND RED - CAPPED/SW LEAD VIOLET - DIM(+) GREY - DIM(-)</p>	 <p>BLACK - LINE WHITE - NEUTRAL GREEN - GROUND RED - CAP OFF</p>	 <p>BLACK - LINE WHITE - NEUTRAL GREEN - GROUND RED - UNSWITCHED HOT</p>

CROSS SECTIONS

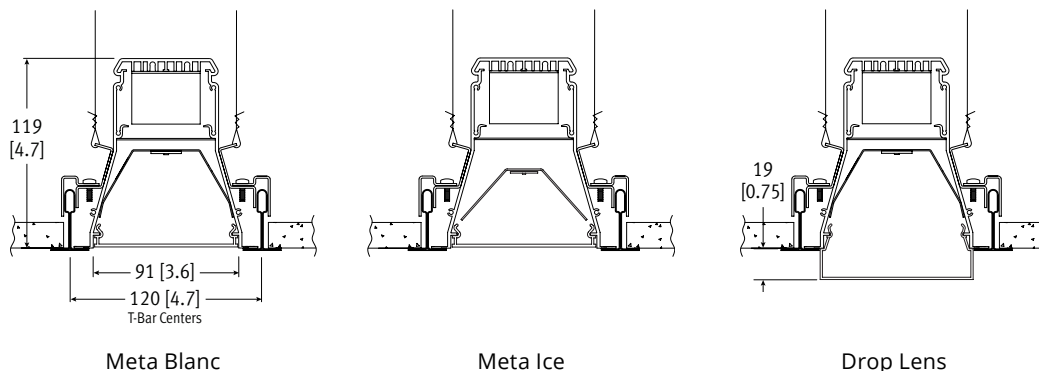

SPECIFICATIONS

Due to the Continuous Improvement Policy at Metalumen, we reserve the right to change our specifications without notice.

Housing: Rigid extruded aluminum body, 2.0mm (0.08”) nominal wall thickness. Aluminum end caps.

Optical System: Metalumen luminaires are designed to utilize leading edge LED technology combined with luminaire optimized reflectors and our custom diffusers, resulting in industry leading optical performance.

CRI: 83+ for 3500K, 80 minimum for all CCTs in standard configurations.

Lumen Maintenance: Minimum 50,000h with TM-21 lumen maintenance of 85% @ 25°C ambient temperature (calculated based on IESNA LM-80-08 LED test data). L70: ≥60,000hrs.

Finish: Satin aluminum and white are standard finishes. For custom finish,

contact factory.

Weight: 2.1 kg/300mm [4.6 lb/ft]

Mounting: Mounting brackets/clips provided. Fits 9/16” and 15/16” T-bar.

Electrical: Factory prewired with easy wire quick connect sections.

Drivers: Metalumen offers 0-10V dimming as a standard on our entire LED product offering. Dimming range is 1%-100%. Power factor is > 90%. Class

2 rating. Drivers are integral.

Approvals: Certified to NRTL and IES testing standards. This product is cULus listed. RoHS compliant. Plenum - CCEA approved.

Environment: Suitable for dry or damp locations.

WARRANTY

Metalumen will warrant defective luminaires for 5 years from date of purchase. Warranty is valid if luminaire is installed and used according to specification. If defective, Metalumen will send replacement boards or drivers at no cost along with detailed replacement instructions and instructions on how to return defective components to Metalumen.

PHOTOMETRIC DATA - 3500K, 80 CRI

Optics: **Meta Blanc**
 IES File: **RM4D-1L35K-4-MB-L3**
 Lumens: **596/ft** Wattage: **6.1/ft**
 Efficacy: **99 lm/W**

PHOTOMETRIC CURVE

100% Down

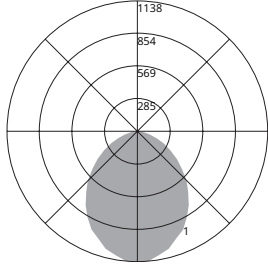

ZONAL LUMEN SUMMARY

Zone	Lumens	%Fixt
0-20	396	16.6
0-30	811	34
0-40	1269	53.2
0-60	2029	85.1
0-80	2359	98.9
0-90	2386	100
10-90	2280	95.6
20-40	873	36.6
20-50	1297	54.4
40-70	983	41.2
60-80	330	13.8
70-80	108	4.5
80-90	26	1.1
90-110	0	0
90-120	0	0
90-130	0	0
90-150	0	0
90-180	0	0
110-180	0	0
0-180	2386	100

COEFFICIENTS OF UTILIZATION

Zonal Cavity Method | Effective Floor Cavity Reflectance = .20

RC	80				70				50			
	RW	70	50	30	10	70	50	30	10	50	30	10
RCR												
0	119	119	119	119	116	116	116	116	111	111	111	111
1	110	106	102	98	107	103	100	97	99	96	94	
2	101	93	87	82	98	92	86	81	88	83	79	
3	93	83	76	70	90	82	75	69	79	73	68	
4	85	74	66	60	83	73	65	60	71	64	59	
5	79	67	59	52	77	66	58	52	64	57	52	
6	73	61	52	46	71	60	52	46	58	51	46	
7	68	55	47	41	67	55	47	41	53	46	41	
8	64	51	43	37	62	50	42	37	49	42	37	
9	60	47	39	34	58	46	39	34	45	38	34	
10	56	43	36	31	55	43	36	31	42	35	31	

CANDELA DISTRIBUTION

Vertical Angle	Horizontal Angle				
	0	22.5	45	67.5	90
0	1138	1138	1138	1138	1138
5	1133	1116	1097	1111	1089
10	1095	1085	1087	1075	1079
15	1060	1040	1037	1018	1011
20	992	985	976	956	953
25	944	923	906	883	867
30	864	842	818	792	787
35	785	766	730	698	689
40	691	676	640	604	594
45	609	585	550	513	499
50	508	492	458	423	408
55	422	404	375	345	331
60	333	321	297	268	260
65	256	245	222	200	197
70	180	172	156	141	137
75	113	111	99	89	83
80	61	58	52	48	44
85	24	22	19	18	18
90	6	5	4	4	4

LUMINANCE DATA (CD/M²)

Vertical Angle	Horizontal Angle		
	0	45	90
45	6758	3654	2909
55	5592	2577	1949
65	4364	1635	1211
75	2843	811	552
85	1181	181	131

Optics: **Meta Ice**
 IES File: **RM4D-1L35K-4-M-L3**
 Lumens: **662/ft** Wattage: **6.1/ft**
 Efficacy: **109 lm/W**

PHOTOMETRIC CURVE

100% Down

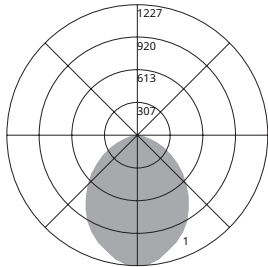

ZONAL LUMEN SUMMARY

Zone	Lumens	%Fixt
0-20	428	16.1
0-30	882	33.3
0-40	1389	52.4
0-60	2245	84.8
0-80	2619	98.9
0-90	2649	100
10-90	2535	95.7
20-40	962	36.3
20-50	1438	54.3
40-70	1108	41.8
60-80	374	14.1
70-80	122	4.6
80-90	30	1.1
90-110	0	0
90-120	0	0
90-130	0	0
90-150	0	0
90-180	0	0
110-180	0	0
0-180	2649	100

COEFFICIENTS OF UTILIZATION

Zonal Cavity Method | Effective Floor Cavity Reflectance = .20

RC	80				70				50			
	RW	70	50	30	10	70	50	30	10	50	30	10
RCR												
0	119	119	119	119	116	116	116	116	111	111	111	111
1	110	106	102	98	107	103	100	97	99	96	94	
2	101	93	87	82	98	91	86	81	88	83	79	
3	93	83	75	69	90	81	74	69	78	72	67	
4	85	74	66	60	83	73	65	59	70	64	58	
5	79	67	58	52	77	66	58	52	63	56	51	
6	73	60	52	46	71	59	51	46	58	51	45	
7	68	55	47	41	66	54	46	41	53	46	40	
8	63	50	42	37	62	50	42	37	49	41	36	
9	59	47	39	33	58	46	38	33	45	38	33	
10	56	43	35	30	55	43	35	30	42	35	30	

CANDELA DISTRIBUTION

Vertical Angle	Horizontal Angle				
	0	22.5	45	67.5	90
0	1227	1227	1227	1227	1227
5	1220	1193	1190	1215	1189
10	1183	1171	1159	1171	1152
15	1122	1117	1118	1098	1109
20	1074	1067	1056	1046	1043
25	1010	1004	987	969	960
30	936	930	912	881	873
35	846	838	817	787	770
40	750	744	714	685	670
45	656	645	619	589	577
50	562	548	520	487	475
55	464	452	421	396	384
60	373	360	334	311	303
65	279	276	253	233	225
70	201	194	177	162	156
75	127	123	111	100	98
80	67	65	59	55	52
85	26	25	22	20	19
90	7	5	5	5	5

LUMINANCE DATA (CD/M²)

Vertical Angle	Horizontal Angle		
	0	45	90
45	7275	4112	3367
55	6142	2892	2261
65	4764	1861	1381
75	3194	909	647
85	1318	208	144

Optics: **Drop Lens**
 IES File: **RM4D-1L35K-4-MD-L3**
 Lumens: **608/ft** Wattage: **6.1/ft**
 Efficacy: **100 lm/W**

PHOTOMETRIC CURVE

6% Up

94% Down

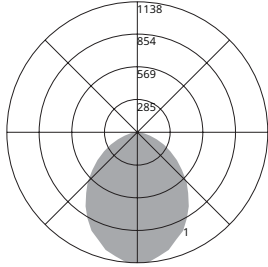

ZONAL LUMEN SUMMARY

Zone	Lumens	%Fixt
0-20	361	14.80
0-30	738	30.30
0-40	1152	47.30
0-60	1862	76.50
0-80	2230	91.60
0-90	2296	94.40
10-90	2200	90.40
20-40	791	32.50
20-50	1180	48.50
40-70	941	38.70
60-80	368	15.10
70-80	137	5.60
80-90	66	2.70
90-110	71	2.90
90-120	96	3.90
90-130	115	4.70
90-150	134	5.50
90-180	137	5.60
110-180	67	2.70
0-180	2434	100.00

COEFFICIENTS OF UTILIZATION

Zonal Cavity Method | Effective Floor Cavity Reflectance = .20

RC	80				70				50			
	RW	70	50	30	10	70	50	30	10	50	30	10
RCR												
0	118	118	118	118	114	114	114	114	108	108	108	108
1	108	103	99	95	104	100	96	93	95	92	89	
2	98	90	84	78	95	88	82	77	84	79	74	
3	90	80	72	66	87	78	71	65	74	68	63	
4	83	71	63	57	80	70	62	56	67	60	55	
5	77	64	56	49	74	63	55	49	60	53	48	
6	71	58	50	43	69	57	49	43	55	47	42	
7	66	53	45	39	64	52	44	38	50	43	38	
8	62	49	40	35	60	48	40	34	46	39	34	
9	58	45	37	31	56	44	36	31	42	36	31	
10	54	41	34	29	53	41	33	28	39	33	28	

CANDELA DISTRIBUTION

Vertical Angle	Horizontal Angle				
	0	22.5	45	67.5	90
0	1025	1025	1025	1025	1025
5	1006	1039	1007	1028	1033
10	987	979	981	992	975
15	947	947	938	940	917
20	911	898	889	870	861
25	850	838	818	798	789
30	787	776	750	717	709
35	705	693	654	634	618
40	622	604	576	553	542
45	536	528	501	482	472
50	452	449	422	411	406
55	374	367	354	349	347
60	299	295	290	292	289
65	219	227	233	238	236
70	158	168	181	189	187
75	101	113	133	142	146
80	55	68	91	107	110
85	23	38	64	77	82
90	5	22	46	60	64

LUMINANCE DATA (CD/M²)

Vertical Angle	Horizontal Angle		
	0	45	90
45	5864	3072	2506
55	4860	2210	1834
65	3633	1532	1281
75	2412	953	839
85	1032	520	520

Photometric performance is measured and scaled in accordance with IESNA LM-79.