

RAIL 2 RM2D

LED . RECESSED T-BAR . DIRECT



PART #:	
PREP BY:	DATE:
PROJECT:	QTY:
NOTES:	
APPROVAL SIGNATURE:	DATE (DD/MM/YYYY):

PERFORMANCE SUMMARY @ 3500K		Meta Blanc (MB)	Meta Ice (M)	Drop Lens (MD)	Meta Asym. (MA)
		L3	L3	L3	L3
Lumens per foot	80 CRI	595	671	624	660
	90 CRI	521	587	546	578
Wattage per foot		6.0			
Efficacy (lm/W)	80 CRI	98	111	103	109
	90 CRI	87	98	91	96
L70 Estimate (h)		≥ 60,000 hrs			

See page 2 for the complete Light Level Performance chart.

FEATURES

- 3/4" drop lens with seamless lines of light without pixels or shadows
- Integral drivers
- Option for daylight harvesting, occupancy sensing, dimming control and emergency lighting
- Optional Illuminated by BIOS version for Healthy Lighting and Well Building Applications

ORDERING LOGIC

Example Part Number: RM2D-1L35K-12-MB-W-L31-T-1-DW-90

RM2D														
1	2	3	4	5	6	7	8	9	10	11	12	13		
1. SERIES RM2D	2. COLOR TEMP 1L30K 3000K 1L35K 3500K 1L40K 4000K		3. LENGTH 2 2 ft 3 3 ft 4 4 ft 5 5 ft 6 6 ft 7 7 ft 8 8 ft 9 9 ft 10 10 ft 11 11 ft 12 12 ft RA Continuous Rows Replace "A" with length in feet C Custom Length* - None (leave space empty)			4. PATTERN ¹ GA Square GAxB Rectangle UAxBxC U-Shape LAxB L-Shape C Custom Pattern* - None (leave space empty)				5. OPTICS MB Meta Blanc M Meta Ice MD Drop Lens ** MA Meta Asymmetric		6. FINISH SA Satin Aluminum W White B Black C Custom Finish Specify RAL:		
7. LIGHT LEVEL / DRIVER L1 L2^B L3^B L4^B LX	8. CIRCUITRY 1 1 Circuit EM Emergency / Night Light B Emergency Battery Pack ²		9. MOUNTING T Recessed T-Bar (Suitable for 15/16" & 9/16" T-Bar)			10. VOLTAGE 1 120V 2 277V 3 347V 4 UNV (120-277V)		11. SENSORS		12. SENSORS		13. OPTIONS 90 90 CRI, High R9 BS BIOS Static BD BIOS Dynamic - None (leave space empty)		
Select Driver below. See Light Level Performance chart on p2.								Please see last page for fixture integrated SENSORS and CONTROLS Order Logic codes						
Enter desired lm/ft:														

*Consult factory. | ** Drop lens is not available with patterns. | ¹ Pattern approval drawings showing mounting locations will be sent out upon order. | ² Battery operates 4ft sections only. | ^B Available with BIOS

Select Driver:

- Factory option 0-10V, 1% Dimming
- LHE** Lutron H-Series Hi-lume 1% EcoSystem LED Driver
- LA2** Lutron A-Series Hi-lume 1% 2-wire LED Driver
- L5E** Lutron 5-Series EcoSystem LED Driver

Light Level Performance

3500K, 80 CRI, 0-10V Dimming (Standard)

Light Level	Meta Blanc (MB)			Meta Ice (M)			Drop Lens (MD)			Meta Asymmetric (MA)		
	Lumens per foot	Wattage per foot	Efficacy (lm/W)	Lumens per foot	Wattage per foot	Efficacy (lm/W)	Lumens per foot	Wattage per foot	Efficacy (lm/W)	Lumens per foot	Wattage per foot	Efficacy (lm/W)
L1	350	3.5	101	408	3.5	118	367	3.5	104	401	3.5	116
L2	438	4.4	99	503	4.4	114	459	4.4	103	495	4.4	112
L3	595	6.0	98	671	6.0	111	624	6.0	103	660	6.0	109
L4	1105	12.1	91	1236	12.1	102	1158	12.5	92	1079	10.6	102

Lumen Adjustment Factor (Standard)

Color Temp	80 CRI	90 CRI
3000K	0.984	0.880
3500K	1.000	0.875
4000K	1.032	0.879

BIOS 3500K

	Meta Blanc (MB)			Meta Ice (M)			Drop Lens (MD)			Meta Asymmetric (MA)			
	Lumens per foot	Wattage per foot	Efficacy (lm/W)	Lumens per foot	Wattage per foot	Efficacy (lm/W)	Lumens per foot	Wattage per foot	Efficacy (lm/W)	Lumens per foot	Wattage per foot	Efficacy (lm/W)	
Distribution % (Up/Down)	0 / 100			0 / 100			6 / 94			0 / 100			
Static	L2	582	9.4	62	646	9.4	69	640	9.4	68	633	9.4	67
	L3	775	13.3	58	861	13.3	65	853	13.3	64	844	13.3	63
	L4	947	17.2	55	1052	17.2	61	1042	17.2	61	947	17.2	55
Dynamic	L2	523	9.4	55	582	9.4	62	576	9.4	61	570	9.4	61
	L3	697	13.3	52	775	13.3	58	768	13.3	58	760	13.3	57
	L4	852	17.2	50	947	17.2	55	938	17.2	55	852	17.2	50
R9							≥ 90						
COI**							< 3.3						
EML or M/P*							0.8						

* EML or M/P is a ratio that describes the relative melanopic lux (M) versus the photopic lux (P). BIOS provides the following m/p values: 3000K = 0.7, 3500K = 0.8, 4000K = 0.9. ** COI - Cyanosis Observation Index.

BIOS Naming Convention Reference

BIOS	Static	
	3500K	35BIOSST
BIOS	4000K	40BIOSST
	Dynamic	
BIOS	3500K	35BIOSDY
	4000K	40BIOSDY

BIOS | Lumen Adjustment Factor (LAF)

Color Temp	LAF
3500K	1.00
4000K	1.05

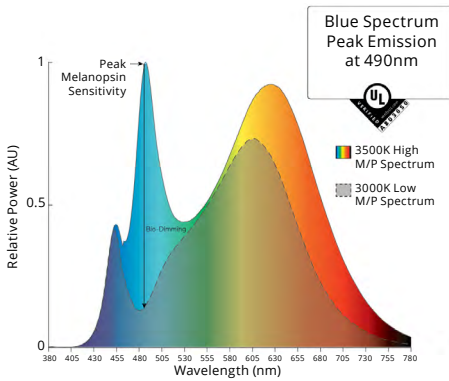

Metalumen's light level performance metrics are subject to manufacturers component tolerances.

PATTERNS

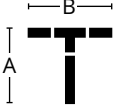
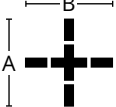

Select Pattern:	<input type="checkbox"/> T-SHAPE (C)	<input type="checkbox"/> CROSS / X-SHAPE (C)
Pattern Configuration		
Indicate Desired Lengths (ft)	A = B =	A = B =
Minimum Lengths	A = 3 ft B = 6 ft	A = 6 ft B = 6 ft

A custom pattern configuration drawing is required in the grid below

Approval drawings will be sent out upon order showing mounting locations.



WIRING

Standard	Emergency / Night Light	Emergency Battery Pack
 <p>BLACK - LINE WHITE - NEUTRAL GREEN - GROUND RED - CAPPED/SW LEAD VIOLET - DIM(+) PINK - DIM(-)</p>	 <p>BLACK - LINE WHITE - NEUTRAL GREEN - GROUND RED - CAP OFF</p>	 <p>BLACK - LINE WHITE - NEUTRAL GREEN - GROUND RED - UNSWITCHED HOT</p>

CROSS SECTIONS

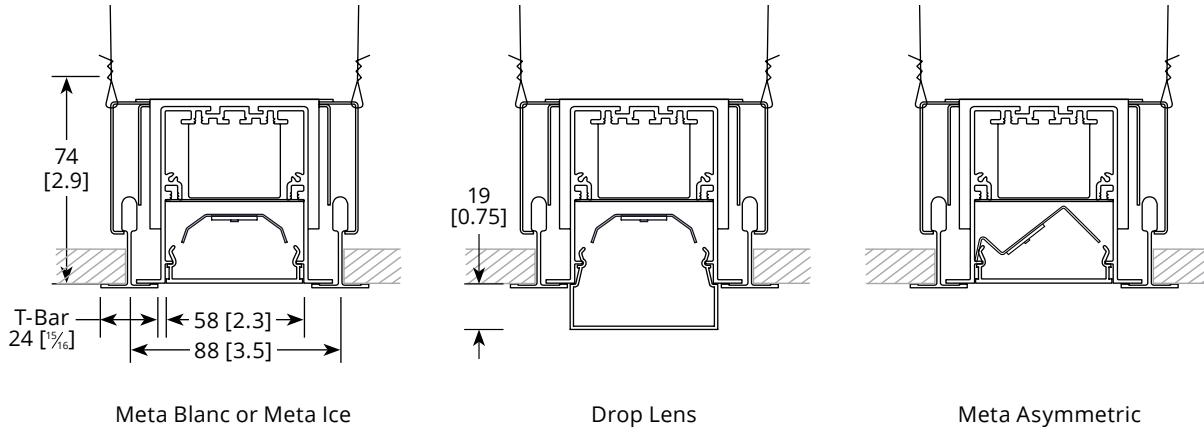

SPECIFICATIONS

Due to the Continuous Improvement Policy at Metalumen, we reserve the right to change our specifications without notice.

Housing: Rigid extruded aluminum body, 2.0mm (0.08") nominal wall thickness. Aluminum end caps.
Optical System: Metalumen luminaires are designed to utilize leading edge LED technology combined with luminaire optimized reflectors and our custom diffusers, resulting in industry leading optical performance.
BIOS LED: BIOS SkyBlue® solutions have a peak wavelength at 490nm to provide an enhanced spectrum with high M/P (melanopic to photopic)

ratios while also providing a low Cyanosis Observation Index (COI), making it ideally suited for Healthcare and Healthy Lighting projects. BIOS® SkyBlue® lighting solutions also contribute to satisfying Circadian Lighting Design Feature for WELL Building Standard v1 and v2. BIOS is not suitable for insulated ceilings.
CRI: 83+ for 3500K, 80 minimum for all CCTs in standard configurations.
Lumen Maintenance: Minimum 50,000h with TM-21 lumen maintenance of 85% @ 25°C ambient

temperature (calculated based on IESNA LM-80-08 LED test data). L70: ≥60,000hrs.
Finish: Satin aluminum, white and black are standard finishes. For custom finish, contact factory.
Weight: 0.95 kg/300mm [2.1 lb/ft]
Mounting: Mounting brackets/clips provided. Suitable for 15/16" and 9/16" T-bars.
Electrical: Factory prewired with easy wire quick connect sections.
Drivers: Metalumen offers 0-10V dimming* as a standard on our entire

LED product offering. Dimming range is 1%-100%. Power factor is > 90%. Class 2 rating. Drivers are integral.
Approvals: This product is cULus listed. All components are UL/CSA/QPS recognized or listed. RoHS compliant.
Environment: Suitable for dry or damp locations.

**Standard drivers compatible with passive/sinking dimmers. Please contact Metalumen if active/sourcing dimmer support is required.*

WARRANTY

Metalumen will warrant defective luminaires for 5 years from date of purchase. Warranty is valid if luminaire is installed and used according to specification. If defective, Metalumen will send replacement boards or drivers at no cost along with detailed replacement instructions and instructions on how to return defective components to Metalumen.

PHOTOMETRIC DATA - 3500K, 80 CRI

Optics: **Meta Blanc**
 IES File: **RM2D-1L35K-4-MB-L3**
 Lumens: **595/ft** Wattage: **6.1/ft**
 Efficacy: **98 lm/W**

ZONAL LUMEN SUMMARY

Zone	Lumens	%Fixt
0-90	2385	100
90-180	0	0
0-180	2385	100

LUMINANCE DATA (CD/M2)

Vertical Angle	Horizontal Angle		
	0	45	90
45	10388	5519	4452
55	8871	3893	2959
65	7139	2495	1791
75	4884	1188	836
85	2111	270	200

PHOTOMETRIC CURVE
 100% Down

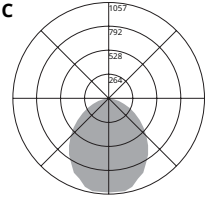

Optics: **Meta Ice**
 IES File: **RM2D-1L35K-4-M-L3**
 Lumens: **671/ft** Wattage: **6.1/ft**
 Efficacy: **111 lm/W**

ZONAL LUMEN SUMMARY

Zone	Lumens	%Fixt
0-90	2689	100
90-180	0	0
0-180	2689	100

LUMINANCE DATA (CD/M2)

Vertical Angle	Horizontal Angle		
	0	45	90
45	11845	6275	4993
55	9920	4438	3396
65	7941	2807	2061
75	5544	1370	955
85	2386	307	215

PHOTOMETRIC CURVE
 100% Down

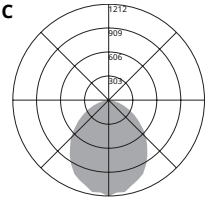

Optics: **Drop Lens**
 IES File: **RM2D-1L35K-4-MD-L3**
 Lumens: **624/ft** Wattage: **6.1/ft**
 Efficacy: **103 lm/W**

ZONAL LUMEN SUMMARY

Zone	Lumens	%Fixt
0-90	2305	92
90-180	194	8
0-180	2499	100

LUMINANCE DATA (CD/M2)

Vertical Angle	Horizontal Angle		
	0	45	90
45	8674	4407	3743
55	7203	3296	2876
65	5615	2352	2073
75	3834	1535	1407
85	1789	937	890

PHOTOMETRIC CURVE
 8% Up
 92% Down

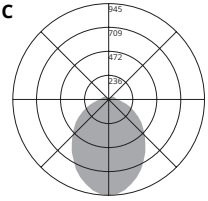

Optics: **Meta Asymmetric**
 IES File: **RM2D-1L35K-4-MA-L3**
 Lumens: **660/ft** Wattage: **6.0/ft**
 Efficacy: **109 lm/W**

ZONAL LUMEN SUMMARY

Zone	Lumens	%Fixt
0-90	2645	100
90-180	0	0
0-180	2645	100

LUMINANCE DATA (CD/M2)

Vertical Angle	Horizontal Angle		
	0	45	90
45	4188	5364	11647
55	2957	3990	10258
65	1997	2648	8589
75	1002	1412	6107
85	277	389	2650

PHOTOMETRIC CURVE
 100% Down

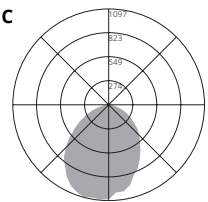

Photometric performance is measured and scaled in accordance with IESNA LM-79.

SENSORS AND CONTROLS



Metalumen offers intelligent standalone and/or connected luminaires with various integrated sensing and control system* connectivity options. The table below outlines some of the more common combinations and solutions offered. If you do not see the controls solution or the type of sensing technology you require for your project please contact us and we will work with you to try and identify a solution to meet your needs.

*Control system, installation and commissioning provided by others.

Examples:

WattStopper Daylight Sensor Standalone Luminaire: RM2D-1L35K-12-MB-W-L31-T-1-DW-90

Occupancy Sensor with Casambi Wireless Bluetooth Mesh Control Capability: RM2D-1L35K-12-MB-W-L31-T-1-O-CAB-90

ORDER LOGIC FIELDS		SENSOR FEATURE / BEHAVIOR		LUMINAIRE CONTROL / CONNECTIVITY	DESCRIPTION
11. SENSORS	12. CONTROLS	OCCUPANCY (PIR)	DAYLIGHT HARVESTING		
OF	-		None	Standalone	Factory Sensor - Occupancy Behaviors configured via BLE App
OW	-		None	Standalone (WattStopper)	Wattstopper Standalone Occupancy Sensor
DW	-	None		Standalone (WattStopper)	Wattstopper Standalone Daylight Harvesting Sensor
ODW	-			Standalone (WattStopper)	Wattstopper Standalone Occupancy and Daylight Harvesting Sensors
O	- CAB		None	Casambi Bluetooth Mesh	Casambi Bluetooth Mesh Connectivity with Occupancy Sensing
OD	- CAB			Casambi Bluetooth Mesh	Casambi Bluetooth Mesh Connectivity with Daylight Harvesting and Occupancy Sensing
	- CAB	None	None	Casambi Bluetooth Mesh	Casambi Bluetooth Mesh Connectivity (no sensors)
O	- SLVR		None	Silvair Bluetooth Mesh	Open Standard Bluetooth Mesh Connectivity with Occupancy Sensing
OD	- SLVR			Silvair Bluetooth Mesh	Open Standard Bluetooth Mesh Connectivity with Daylight Harvesting and Occupancy Sensing
	- SLVR	None	None	Silvair Bluetooth Mesh	Open Standard Bluetooth Mesh Connectivity (no sensors)
	- OSRM	None	None	Osram Enceium	Osram Enceium connectivity
OD	- OSRM			Osram Enceium	Osram SensiLum Connectivity for Enceium with Occupancy and Daylight Harvesting
OD	- ENL			Enlighted ONE	Occupancy and Daylight Harvesting Capable Supports EnlightedONE room control as well and upgrade path for Enlighted Connected and Enlighted IoT offering advanced applications, analytics and insights for Space Utilization/Optimization, Asset Tracking, Energy Monitoring, HVAC Integration etc..
	- DALI	None	None	DALI addressable wired Luminaire	Generic DALI addressable luminaire
	- ECOS	None	None	Lutron Ecosystem	Lutron Ecosystem addressable wired luminaire NOTE: See Driver Selection options for specific driver

