



**NOTE:** The following instructions provide general guidelines for product installation. For additional information consult the applicable electrical codes or contact factory directly for support before attempting anything with uncertainty.

**CAUTION:** Do not assemble fixture runs on floor.

**WARNING:** Risk of fire and electrical shock. **DISCONNECT POWER AT ELECTRICAL PANEL** before installing or servicing this product.

### GENERAL SAFETY INSTRUCTIONS:

1. Read all instructions prior to installing this fixture.
2. This product must be installed in accordance with the applicable installation code by a person familiar with the construction and operation of the product and the hazards involved.
3. All wiring must be performed by a qualified electrician in accordance with national and local building and electrical codes.
4. This fixture must be suitably grounded for your protection against shock hazards and to assure proper operation.
5. Make sure that the power source conforms to the requirements of this fixture.

Specifications and design subject to change without notice.

**PARTS LIST**

**MAIN PARTS LIST**

- A. Luminaire Enclosure
- B. Tbar Hanger Bracket
- C. End Plate
- D. Lens
- E. Lens Filler & Magnet
- F. Retainer Clip
- G. Joiner Plate (Middle and Start units only)

**OTHER PARTS**

- Reflector
- Lamp (supplied or by others)

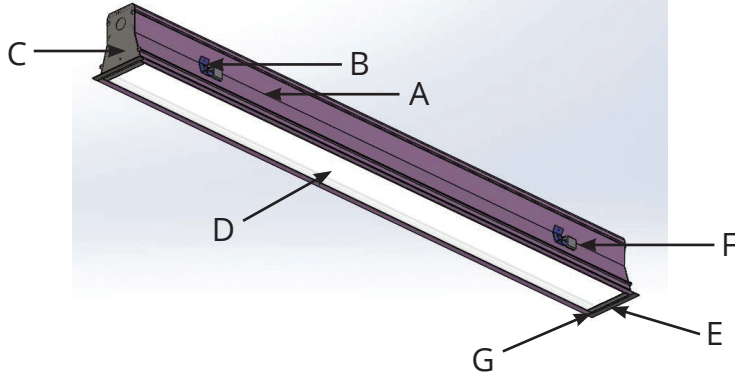

**WIRING DIAGRAMS**

**STANDARD WIRING**

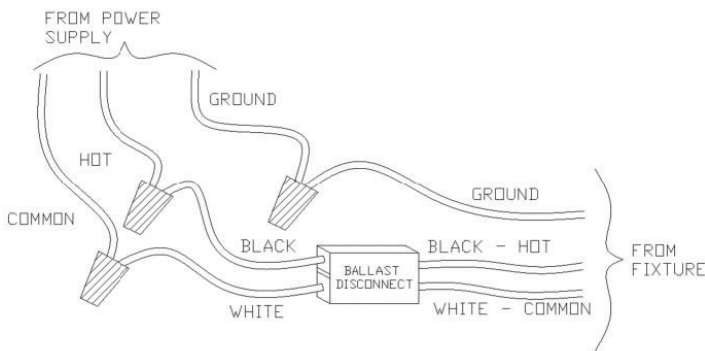

**WITH OPTIONAL EMERGENCY PACK**

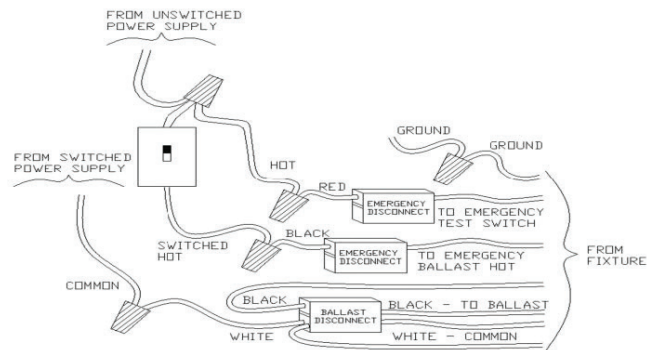

Specifications and design subject to change without notice.

STEP-BY-STEP INSTRUCTIONS



**STEP 1.** Remove fixture packaging; note marked supply wires coming out at one end of the Start luminaire and wires for row mounting connections at the opposite end.

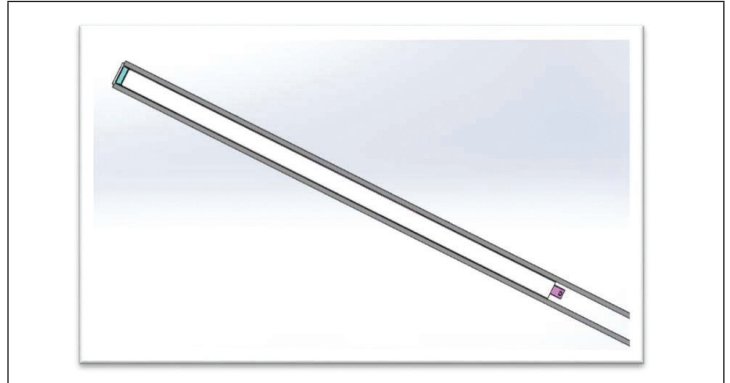

**STEP 2.** Install Start luminaire following standard installation instructions. Do not apply power to the fixture.

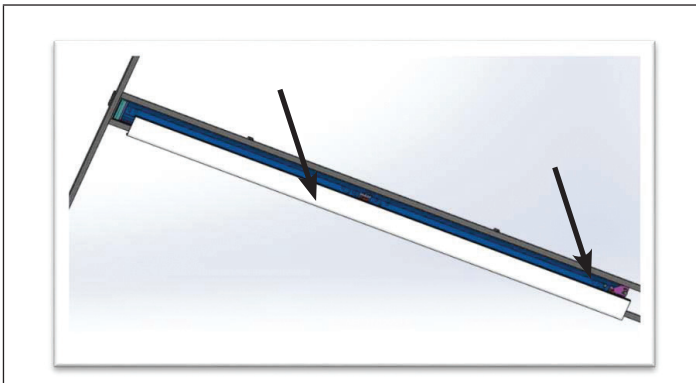

**STEP 3.** Remove lens starting at one end. Pull one side first, rotate and detach. Then remove plug at joining end of reflector to access joining kit.

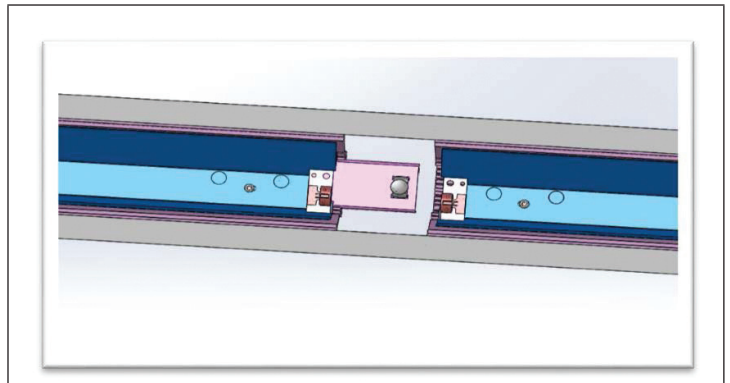

**STEP 4.** Remove lens and reflector plug on mid fixture. Make all necessary electrical connections from start fixture through mid/end fixtures. Then slide mid fixture; butt up to start fixture then fasten screw to wedge joiner kit. Repeat for remainder of run.

Specifications and design subject to change without notice.

STEP-BY-STEP INSTRUCTIONS



**STEP 5.** Remove reflector mounting screws and reflector. Note fixtures with optional emergency pack have a test switch and indicator light mounted on the reflector.



**STEP 6.** Perform electrical wiring inside the fixture and re-attach reflector with (2) mounting screws. Optional emergency ballast must be fed from the same branch circuit as the AC ballast.

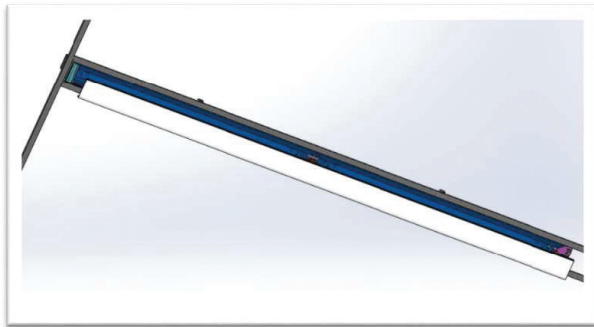

**STEP 7.** Install Lamps and re-attach lens. Start with one side first and close the other side starting from the corner.

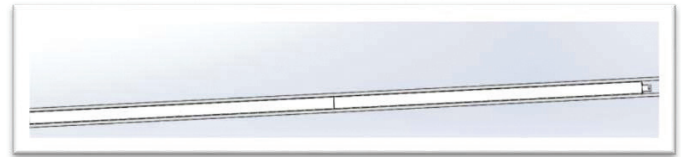

**STEP 8.** Joined luminaires. Complete remaining fixtures installation as needed.

Specifications and design subject to change without notice.