

RAIL 4 RM4DI

LED . PENDANT . DIRECT/INDIRECT



PART #:		DATE:	
PREP BY:		QTY:	
PROJECT:		NOTES:	
APPROVAL SIGNATURE:		DATE (DD/MM/YYYY):	

PERFORMANCE SUMMARY @ 3500K

		MBMB	MBMD	MRMD	MM
		L3			
Lumens per foot	80 CRI	1274	1290	1300	1352
	90 CRI	1115	1129	1138	1183
Distribution (Up / Down %)		51 / 49	53 / 47	51 / 49	51 / 49
Wattage per foot		12.1	12.1	12.1	12.1
Efficacy	80 CRI	106	107	107	112
	90 CRI	92	93	94	98
L70 Estimate (h)		≥ 60,000 hrs			

See page 2 for the complete Light Level Performance chart.

FEATURES

- 3/4 " drop lens with seamless lines of light without pixels or shadows
- Integral drivers
- Option for daylight harvesting, occupancy sensing , dimming control and emergency lighting
- Optional Illuminated by BIOS version for Healthy Lighting and Well Building Applications

ORDERING LOGIC

Example Part Number: RM4DI-2L35K-12-MBMB-W-L31-PA18-1-DW-90

RM4DI												
1	2	3	4	5	6	7	8	9	10	11	12	13
1. SERIES RM4DI	2. COLOR TEMP 2L30K 3000K 2L35K 3500K 2L40K 4000K 90 CRI is available under OPTIONS BIOS is available under OPTIONS. See p2 for BIOS Naming Convention Reference	3. LENGTH 2 2 ft 3 3 ft 4 4 ft 5 5 ft 6 6 ft 7 7 ft 8 8 ft 9 9 ft 10 10 ft 11 11 ft 12 12 ft RA Continuous Rows Replace "A" with length in feet selected on p3 C Custom Length* - None (leave space empty)	4. PATTERN ¹ GA Square GAxB Rectangle UAxBxC U-Shape LAxB L-Shape C Custom Pattern* - None (leave space empty) Standard Patterns Minimum Lengths Square: A=4 ft min, B=4 ft min. Rectangle: A=3 ft min, B=4 ft min. U-Shape: A=3 ft min, B=4 ft min, C=3 ft min. L-Shape: A=3 ft min, B=3 ft min. Custom Patterns* Lengths and a drawing of custom pattern are required on page 4 T-Shape, Cross/X Select corner: <input checked="" type="checkbox"/> Outside 90° <input checked="" type="checkbox"/> Inside 90° 	5. OPTICS MBMB Up: Meta Blanc Down: Meta Blanc MBMD Up: Meta Blanc Down: Drop Lens ** MRMD Up: Rise Lens Down: Drop Lens ** MM Up: Meta Ice Down: Meta Ice BWMB Up: Batwing ³ Down: Meta Blanc BWMD Up: Batwing ³ Down: Drop Lens ** BWM Up: Batwing ³ Down: Meta Ice Meta Blanc, Rise & Drop Lens: Opal diffuse lens Meta Ice: High output semi-diffuse lens				6. FINISH SA Satin Aluminum W White B Black C Custom Finish Specify RAL:				
7. LIGHT LEVEL / DRIVER L1 ³ L2 Select Driver below. L3 See Light Level Performance chart on p2. L4	8. CIRCUITRY 1 1 Circuit UD Up/Down Switching EM Emergency / Night Light B Emergency Battery Pack ²		9. MOUNTING PAA Pendant Aircraft Cable PTA Pendant Aircraft Cable for T-bar Replace "A" with length (inches) selected below. Select Aircraft Cable Length, Canopy Finish & Power Cord Color below		10. VOLTAGE 1 120 V 2 277 V 3 347 V 4 UNV (120 - 277V)	11. SENSORS 12. CONTROLS Please see last page for fixture integrated SENSORS and CONTROLS Order Logic codes		13. OPTIONS 90 90 CRI, High R9 BS BIOS Static BD BIOS Dynamic - None (leave space empty)				

*Consult factory. | ** Rise lens and Drop lens are not available with patterns. | ¹ Pattern record drawings showing mounting locations will be sent out upon order. | ² Battery operates 4ft direct sections only. | ³ Not available with BIOS.

Select Driver:

- Factory option 0-10V, 1% Dimming
- LHE Lutron H-Series Hi-lume 1% EcoSystem LED Driver
- LA2 Lutron A-Series Hi-lume 1% 2-wire LED Driver
- L5E Lutron 5-Series EcoSystem LED Driver

Select Aircraft Cable Length:

Total adjustment range is 6" up & down for each standard length. All other lengths are considered custom unless otherwise stated. **NOTE: If no selection is made, a 48" hanger will be supplied.**

Select:	Imperial (in)	Metric (mm)
<input type="checkbox"/>	12	305
<input type="checkbox"/>	18	460
<input type="checkbox"/>	24	610
<input type="checkbox"/>	30	760
<input type="checkbox"/>	36	915
<input type="checkbox"/>	42	1067
<input type="checkbox"/>	48	1220

Select:	Imperial (in)	Metric (mm)
<input type="checkbox"/>	54	1372
<input type="checkbox"/>	60	1525
<input type="checkbox"/>	72	1830
<input type="checkbox"/>	96	2440
<input type="checkbox"/>	120	3050
<input type="checkbox"/>	144	3660
<input type="checkbox"/>	Custom Length: _____	

Select Canopy Finish & Power Cord Color

White canopy & cord is standard. **NOTE: If no selection is made, white canopy & cord will be supplied.**

Canopy <input type="checkbox"/> White <input type="checkbox"/> Black <input type="checkbox"/> Custom Finish RAL: _____	Power Cord <input type="checkbox"/> White <input type="checkbox"/> Black* *Consult factory.
---	---

Light Level Performance

3500K, 80 CRI, 0-10V Dimming (Standard)

Distribution % (Up / Down)	MBMB (UP: Meta Blanc / DOWN: Meta Blanc)			MBMD (UP: Meta Blanc / DOWN: Drop Lens)			MRMD (UP: Rise Lens / DOWN: Drop Lens)			MM (UP: Meta Ice / DOWN: Meta Ice)		
	Lumens per foot	Wattage per foot	Efficacy (lm/W)	Lumens per foot	Wattage per foot	Efficacy (lm/W)	Lumens per foot	Wattage per foot	Efficacy (lm/W)	Lumens per foot	Wattage per foot	Efficacy (lm/W)
	51 / 49			53 / 47			51 / 49			51 / 49		
L1	749	7.0	107	758	7.0	108	814	6.9	118	794	7.0	113
L2	937	8.9	106	949	8.8	107	956	8.8	109	997	8.9	113
L3	1274	12.1	106	1290	12.1	107	1300	12.1	108	1352	12.1	112
L4	2363	25.0	95	2393	25.0	96	2412	24.2	100	2639	24.2	109

Standard Lumen Adjustment Factor

Color Temp	80 CRI	90 CRI
3000K	0.984	0.880
3500K	1.000	0.875
4000K	1.032	0.879

BIOS 3500K

Distribution % (Up / Down)	MBMB (UP: Meta Blanc / DOWN: Meta Blanc)			MBMD (UP: Meta Blanc / DOWN: Drop Lens)			MRMD (UP: Rise Lens / DOWN: Drop Lens)			MM (UP: Meta Ice / DOWN: Meta Ice)			
	Lumens per foot	Wattage per foot	Efficacy (lm/W)	Lumens per foot	Wattage per foot	Efficacy (lm/W)	Lumens per foot	Wattage per foot	Efficacy (lm/W)	Lumens per foot	Wattage per foot	Efficacy (lm/W)	
	51 / 49			53 / 47			51 / 49			51 / 49			
Static	L2	1244	18.9	66	1309	18.9	69	1256	18.9	67	1413	18.9	75
	L3	1659	26.6	62	1746	26.6	66	1675	26.6	63	1885	26.6	71
	L4	2016	34.4	59	2122	34.4	62	2035	34.4	59	2291	34.4	67
Dynamic	L2	1119	18.9	59	1178	18.9	62	1130	18.9	59.9	1272	18.9	67
	L3	1493	26.6	56	1571	26.6	59	1507	26.6	56.6	1696	26.6	64
	L4	1814	34.4	53	1910	34.4	56	1832	34.4	53.3	2062	34.4	60

BIOS Lumen Adjustment Factor (LAF)

Color Temp	LAF
3500K	1.00
4000K	1.05

BIOS Naming Convention Reference

BIOS	Static	
	3500K	4000K
Dynamic	3500K	4000K
	35BIOSDY	40BIOSDY

* EML or M/P is a ratio that describes the relative melanopic lux (M) versus the photopic lux (P). BIOS provides the following m/p values: 3000K = 0.7, 3500K = 0.8, 4000K = 0.9. ** COI - Cyanosis Observation Index.

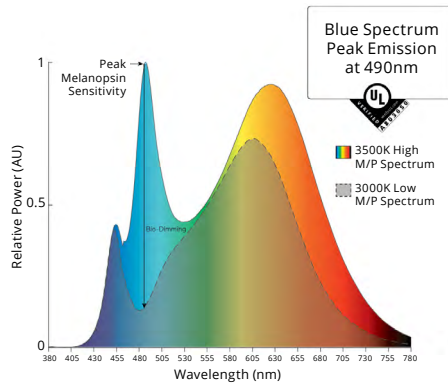

Metalumen's light level performance metrics are subject to manufacturers component tolerances.

CONTINUOUS ROWS

Step 1) Indicate desired quantity of rows under the QTY column

Step 2) ← Pods → If applicable, select pod(s) per row to indicate desired Emergency/Night Light/Battery location. If a similar row requires a different Emergency lighting location, please fill out another sheet.

Record drawings for rows not represented here will be sent out upon order.

QTY	Nominal Length	Run Length Overall	Alone / Start Length	Mid Length(s)	End Length	
					ROWS IN PLAN VIEW Rows are for demonstration purposes only and are not to scale.	
	4'	1225 [48.2]	4		1213 [47.8]	
	8'	2442 [96.1]	8		2430 [95.7]	
	12'	3661 [144.1]	12		3650 [143.7]	
	16'	4881 [192.2]	8	8	2430 [95.7] 2438 [96.0]	
	20'	6100 [240.2]	12	8	3650 [143.7] 2438 [96.0]	
	24'	7319 [288.1]	12	12	3650 [143.7] 3658 [144.0]	
	28'	8538 [336.1]	8	12	8	2430 [95.7] 3658 [144.0] 2438 [96.0]
	32'	9757 [384.1]	12	8	12	3650 [143.7] 2438 [96.0] 3658 [144.0]
	36'	10977 [432.2]	12	12	12	3650 [143.7] 3658 [144.0] 3658 [144.0]
	40'	12196 [480.2]	12	8, 8	12	3650 [143.7] 2438 [96.0] 2438 [96.0] 3658 [144.0]
	44'	13415 [528.1]	12	12, 8	12	3650 [143.7] 3658 [144.0] 2438 [96.0] 3658 [144.0]
	48'	14634 [576.1]	12	12, 12	12	3650 [143.7] 3658 [144.0] 3658 [144.0] 3658 [144.0]

LEGEND

- Standard Wire Entry Location
(located 52mm from end on top of fixture)
- Emergency (EM) / Night Light / Battery Location
- EM or Battery Wire Entry Location
(located 52mm from end on top of fixture)

Mounting Points

A **A**

A = Distance Between Mounting Points

EM / Night Light and EM or Battery Wire Entry location in relation to pod selections:

Example 20 ft run

Refer to page 5 for Hanger information

PATTERNS

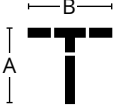
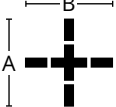
Select Pattern:	<input type="checkbox"/> T-SHAPE (C)	<input type="checkbox"/> CROSS / X-SHAPE (C)
Pattern Configuration		
Indicate Desired Lengths (ft)	A = B =	A = B =
Minimum Lengths	A = 3 ft B = 6 ft	A = 6 ft B = 6 ft

A custom pattern configuration drawing is required in the grid below

Approval drawings will be sent out upon order showing mounting locations.



HANGER

Aircraft Cable & Cord

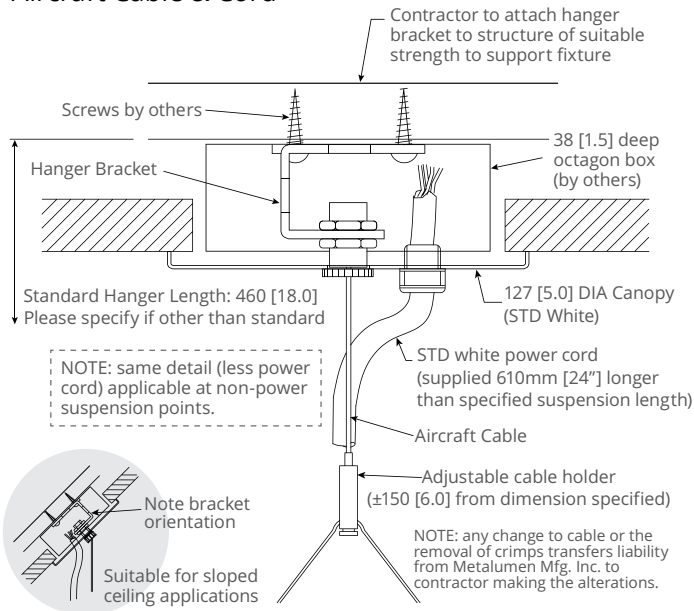

T-Bar Aircraft Cable & Cord

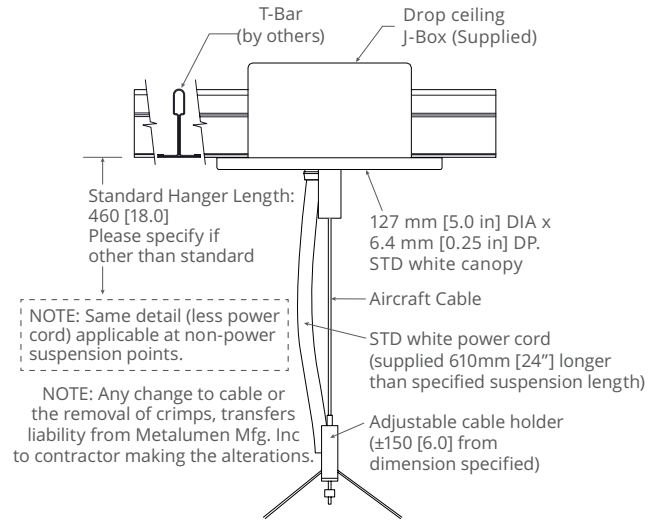

WIRING

Standard	Up/Down Switching	Emergency / Night Light	Emergency Battery Pack
<p>BLACK - LINE WHITE - NEUTRAL GREEN - GROUND RED - CAPPED/SW LEAD VIOLET - DIM(+) PINK - DIM(-)</p>	<p>BLACK - LINE (UP) WHITE - NEUTRAL GREEN - GROUND RED - LINE (DOWN) VIOLET - DIM(+) PINK - DIM(-)</p>	<p>BLACK - LINE WHITE - NEUTRAL GREEN - GROUND RED - CAP OFF</p>	<p>BLACK - LINE WHITE - NEUTRAL GREEN - GROUND RED - UNSWITCHED HOT</p>

CROSS SECTIONS

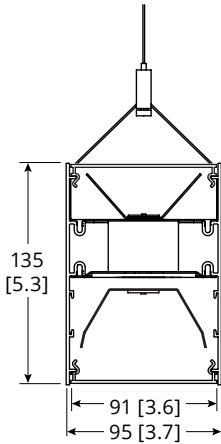

UP: Meta Blanc, DOWN: Meta Blanc
UP: Meta Ice, DOWN: Meta Ice

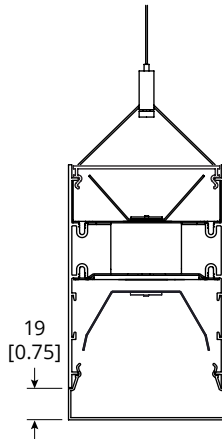

UP: Meta Blanc
DOWN: Drop Lens

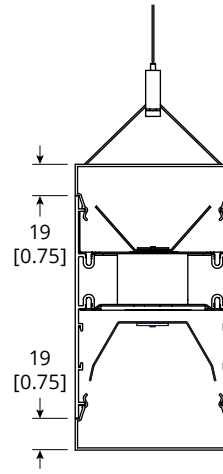

UP: Rise Lens
DOWN: Drop Lens

SPECIFICATIONS

Due to the Continuous Improvement Policy at Metalumen, we reserve the right to change our specifications without notice.

Housing: Rigid extruded aluminum body, 2.0mm (0.08”) nominal wall thickness. Aluminum end caps.

Optical System: Metalumen luminaires are designed to utilize leading edge LED technology combined with luminaire optimized reflectors and our custom diffusers, resulting in industry leading optical performance.

BIOS LED: BIOS SkyBlue® solutions have a peak wavelength at 490nm to provide an enhanced spectrum with high M/P (melanopic to photopic)

ratios while also providing a low Cyanosis Observation Index (COI), making it ideally suited for Healthcare and Healthy Lighting projects. BIOS® SkyBlue® lighting solutions also contribute to satisfying Circadian Lighting Design Feature for WELL Building Standard v1 and v2.

CRI: 83+ for 3500K, 80 minimum for all CCTs in standard configurations.

Lumen Maintenance: Minimum 50,000h with TM-21 lumen maintenance of 85% @ 25°C ambient temperature (calculated based on

IESNA LM-80-08 LED test data). L70: ≥60,000hrs.

Finish: Satin aluminum, white and black are standard finishes. For custom finish, contact factory.

Weight: 2.1 kg/300mm [4.6 lb/ft]

Mounting: Aircraft cable yoke complete with a Quick-Grip field adjustable suspension system provides for quick and easy onsite alignment.

Electrical: Factory prewired with easy wire quick connect sections.

Drivers: Metalumen offers 0-10V

dimming* as a standard on our entire LED product offering. Dimming range is 1%-100%. Power factor is > 90%. Class 2 rating. Drivers are integral.

Approvals: All components are UL/ CSA/QPS recognized or listed. RoHS compliant. This product is cULus listed.

Environment: Suitable for dry or damp locations.

**Standard drivers compatible with passive/ sinking dimmers. Please contact Metalumen if active/sourcing dimmer support is required.*

	DLC Approved RM4DI Products	RM4DI-2L35K-4-MM-xx-L1X-X-XX-[34]-X	RM4DI-2L35K-8-MM-xx-L1X-X-XX-[34]-X	For more Metalumen DLC Approved Products, visit the DLC Website
		RM4DI-2L35K-4-MM-xx-L2X-X-XX-[34]-X	RM4DI-2L35K-8-MM-xx-L2X-X-XX-[34]-X	
		RM4DI-2L35K-4-MM-xx-L3X-X-XX-[34]-X	RM4DI-2L35K-8-MM-xx-L3X-X-XX-[34]-X	
		RM4DI-2L40K-4-MM-xx-L1X-X-XX-[34]-X	RM4DI-2L40K-8-MM-xx-L1X-X-XX-[34]-X	
		RM4DI-2L40K-4-MM-xx-L2X-X-XX-[34]-X	RM4DI-2L40K-8-MM-xx-L2X-X-XX-[34]-X	
		RM4DI-2L40K-4-MM-xx-L3X-X-XX-[34]-X	RM4DI-2L40K-8-MM-xx-L3X-X-XX-[34]-X	

WARRANTY

Metalumen will warrant defective luminaires for 5 years from date of purchase. Warranty is valid if luminaire is installed and used according to specification. If defective, Metalumen will send replacement boards or drivers at no cost along with detailed replacement instructions and instructions on how to return defective components to Metalumen.

PHOTOMETRIC DATA - 3500K, 80 CRI

Optics Up: **Meta Blanc**
 Optics Down: **Meta Blanc**
 IES File: **RM4DI-2L35K-4-MBMB-L3**
 Lumens: **1274/ft** Wattage: **12.1/ft**
 Efficacy: **106 lm/W**

ZONAL LUMEN SUMMARY

Zone	Lumens	%Fixt
0-90	2498	48.0
90-180	2607	51.1
0-180	5105	100.0

LUMINANCE DATA (CD/M2)

Vertical Angle	Horizontal Angle		
	0	45	90
45	6785	3356	2698
55	5602	2338	1768
65	4291	1432	1063
75	2799	698	472
85	1096	154	111

PHOTOMETRIC CURVE

51% Up
49% Down

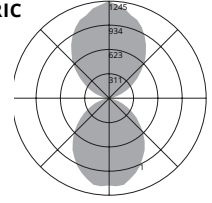

Optics Up: **Meta Blanc**
 Optics Down: **Drop Lens**
 IES File: **RM4DI-2L35K-4-MBMD-L3**
 Lumens: **1290/ft** Wattage: **12.1/ft**
 Efficacy: **107 lm/W**

ZONAL LUMEN SUMMARY

Zone	Lumens	%Fixt
0-90	2405	46.5
90-180	2763	53.5
0-180	5168	100.0

LUMINANCE DATA (CD/M2)

Vertical Angle	Horizontal Angle		
	0	45	90
45	5863	2841	2359
55	4751	2033	1717
65	3676	1377	1175
75	2359	842	744
85	841	444	434

PHOTOMETRIC CURVE

54% Up
47% Down

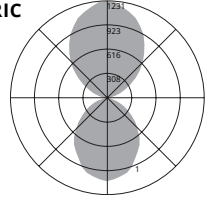

Optics Up: **Rise Lens**
 Optics Down: **Drop Lens**
 IES File: **RM4DI-2L35K-4-MRMD-L3**
 Lumens: **1300/ft** Wattage: **12.1/ft**
 Efficacy: **107 lm/W**

ZONAL LUMEN SUMMARY

Zone	Lumens	%Fixt
0-90	2559	49.1
90-180	2648	50.9
0-180	5207	100

LUMINANCE DATA (CD/M2)

Vertical Angle	Horizontal Angle		
	0	45	90
45	5827	2793	2370
55	4725	2028	1720
65	3546	1436	1255
75	2330	949	904
85	946	658	676

PHOTOMETRIC CURVE

51% Up
49% Down

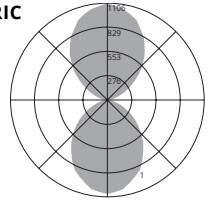

Optics Up: **Meta Ice**
 Optics Down: **Meta Ice**
 IES File: **RM4DI-2L35K-4-MM-L3**
 Lumens: **1352/ft** Wattage: **12.1/ft**
 Efficacy: **112 lm/W**

ZONAL LUMEN SUMMARY

Zone	Lumens	%Fixt
0-90	2624	48.5
90-180	2792	51.5
0-180	5415	100.0

LUMINANCE DATA (CD/M2)

Vertical Angle	Horizontal Angle		
	0	45	90
45	7113	3590	2830
55	5881	2452	1850
65	4429	1503	1098
75	2915	715	502
85	1038	152	110

PHOTOMETRIC CURVE

51% Up
49% Down

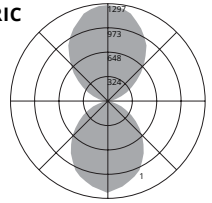

Optics Up: **Batwing**
 Optics Down: **Meta Blanc**
 IES File: **RM4DI-2L35K-4-BWMB-L3**
 Lumens: **1403/ft** Wattage: **12.0/ft**
 Efficacy: **117 lm/W**

ZONAL LUMEN SUMMARY

Zone	Lumens	%Fixt
0-90	2150	38.3
90-180	3461	61.7
0-180	5612	100

LUMINANCE DATA (CD/M2)

Vertical Angle	Horizontal Angle		
	0	45	90
45	6024	6260	5926
55	5807	5972	5563
65	5658	5885	5074
75	5566	5976	4425
85	5622	7123	2935

PHOTOMETRIC CURVE

62% Up
38% Down

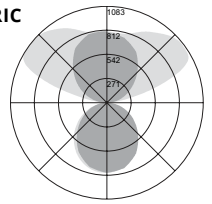

Photometric performance is measured and scaled in accordance with IESNA LM-79.

SENSORS AND CONTROLS



Metalumen offers intelligent standalone and/or connected luminaires with various integrated sensing and control system* connectivity options. The table below outlines some of the more common combinations and solutions offered. If you do not see the controls solution or the type of sensing technology you require for your project please contact us and we will work with you to try and identify a solution to meet your needs.

*Control system, installation and commissioning provided by others.

Examples:

WattStopper Daylight Sensor Standalone Luminaire: RM4DI-2L35K-12-MBMB-W-L31-PA18-1-DW-90

Occupancy Sensor with Casambi Wireless Bluetooth Mesh Control Capability: RM4DI-2L35K-12-MBMB-W-L31-PA18-1-O-CAB-90

ORDER LOGIC FIELDS		SENSOR FEATURE / BEHAVIOR		LUMINAIRE CONTROL / CONNECTIVITY	DESCRIPTION
11. SENSORS	12. CONTROLS	OCCUPANCY (PIR)	DAYLIGHT HARVESTING		
OF	-		None	Standalone	Factory Sensor - Occupancy Behaviors configured via BLE App
OW	-		None	Standalone (WattStopper)	Wattstopper Standalone Occupancy Sensor
DW	-	None		Standalone (WattStopper)	Wattstopper Standalone Daylight Harvesting Sensor
ODW	-			Standalone (WattStopper)	Wattstopper Standalone Occupancy and Daylight Harvesting Sensors
O	- CAB		None	Casambi Bluetooth Mesh	Casambi Bluetooth Mesh Connectivity with Occupancy Sensing
OD	- CAB			Casambi Bluetooth Mesh	Casambi Bluetooth Mesh Connectivity with Daylight Harvesting and Occupancy Sensing
	- CAB	None	None	Casambi Bluetooth Mesh	Casambi Bluetooth Mesh Connectivity (no sensors)
O	- SLVR		None	Silvair Bluetooth Mesh	Open Standard Bluetooth Mesh Connectivity with Occupancy Sensing
OD	- SLVR			Silvair Bluetooth Mesh	Open Standard Bluetooth Mesh Connectivity with Daylight Harvesting and Occupancy Sensing
	- SLVR	None	None	Silvair Bluetooth Mesh	Open Standard Bluetooth Mesh Connectivity (no sensors)
	- OSRM	None	None	Osram Enceium	Osram Enceium connectivity
OD	- OSRM			Osram Enceium	Osram SensiLum Connectivity for Enceium with Occupancy and Daylight Harvesting
OD	- ENL			Enlighted ONE	Occupancy and Daylight Harvesting Capable Supports EnlightedONE room control as well and upgrade path for Enlighted Connected and Enlighted IoT offering advanced applications, analytics and insights for Space Utilization/Optimization, Asset Tracking, Energy Monitoring, HVAC Integration etc..
	- DALI	None	None	DALI addressable wired Luminaire	Generic DALI addressable luminaire
	- ECOS	None	None	Lutron Ecosystem	Lutron Ecosystem addressable wired luminaire NOTE: See Driver Selection options for specific driver

