

RAIL 4 RM4DI

TUNABLE . PENDANT . DIRECT/INDIRECT

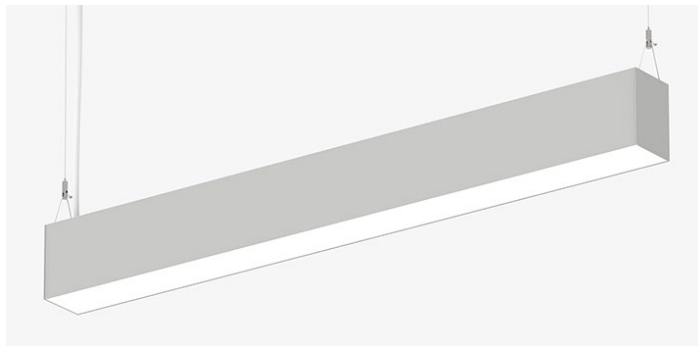

PART #:	
PREP BY:	DATE:
PROJECT:	
NOTES:	
APPROVAL SIGNATURE:	DATE (DD/MM/YYYY):

PERFORMANCE SUMMARY @ 4000K

		MBMB
		L3
Lumens per foot	80 CRI	1154
	90 CRI	1014
Distribution (Up / Down %)		52 / 48
Wattage per foot		11.8
Efficacy (lm/W)	80 CRI	98
	90 CRI	86
L70 Estimate (h)		>60,000 hrs

See page 2 for the complete Light Level Performance chart.

FEATURES

- Independent control of intensity and correlated color temperature (CCT)
- Allows for scheduled mimicking of daylight color temperatures
- Dim-to-Warm simulates warmer CCT shift as luminaire dims (i.e. like traditional incandescent and halogen lights).

ORDERING LOGIC

Example Part Number: RM4DI-2LTUN-12-MBMB-W-L31-PA18-1-D-90

1	2	3	4	5	6	7	8	9	10	11
1. SERIES RM4DI	2. COLOR TEMP 2LTUN Tunable White (2700 - 6500K) 2LDW Dim to Warm* (3500 - 2700K) 90 CRI is available under OPTIONS	3. LENGTH 2 2 ft 3 3 ft 4 4 ft 5 5 ft 6 6 ft 7 7 ft 8 8 ft 9 9 ft 10 10 ft 11 11 ft 12 12 ft RA Continuous Rows (for MBMB optics only) Replace "A" with length in feet selected on the CONTINUOUS ROWS page	4. OPTICS MBMB Up: Meta Blanc Down: Meta Blanc Meta Blanc: Opal diffuse lens	5. FINISH SA Satin Aluminum W White B Black C Custom Finish Specify RAL:	6. LIGHT LEVEL / DRIVER L1 Select Driver below. L2 See Light Level Performance chart on p2. L3 L4	8. CIRCUITRY 1 1 Circuit UD Up/Down Switching EM Emergency / Night Light ¹ B Emergency Battery Pack ²	9. MOUNTING PAA Pendant Aircraft Cable PTA Pendant Aircraft Cable for T-bar Replace "A" with length (inches) selected below. Select Aircraft Cable Length, Canopy Finish & Power Cord Color below	10. VOLTAGE 1 120 V 2 277 V 4 UNV (120 - 277V)	11. CONTROLS / SENSORS _ None (leave space empty) D Daylight Sensor ** O Occupancy Sensor ** DO Daylight and Occupancy Sensors **	12. OPTIONS 90 90 CRI, High R9 _ None (leave space empty)

PLEASE NOTE Dim to Warm is not available with integrated sensors.
Tunable White and Dim to Warm are available with emergency battery packs connected to the cool color.

*Consult factory for alternate range options. | ** Controls intensity only (not CCT). | ¹ Each EM pod, by default, has separate wire entry for DIM and CCT control. | ² Battery operates 4ft direct sections only.

Select Driver:

- Factory option dual 0-10V (Dim & CCT), 1% Dimming
- Lutron T Series EcoSystem, 1% Dimming
- DALI - Factory Option, DT6 Dual Address, 1% Dimming
- DALI - Factory Option, DT8 Single Address Color Control, 1% Dimming
- DALI - EldoLED

Select Aircraft Cable Length:

Total adjustment range is 6" up & down for each standard length. All other lengths are considered custom unless otherwise stated.

Select:	Imperial (in)	Metric (mm)
<input type="checkbox"/>	12	305
<input type="checkbox"/>	18	460
<input type="checkbox"/>	24	610
<input type="checkbox"/>	30	760
<input type="checkbox"/>	36	915
<input type="checkbox"/>	42	1067
<input type="checkbox"/>	48	1220

Select:	Imperial (in)	Metric (mm)
<input type="checkbox"/>	54	1372
<input type="checkbox"/>	60	1525
<input type="checkbox"/>	72	1830
<input type="checkbox"/>	96	2440
<input type="checkbox"/>	120	3050
<input type="checkbox"/>	144	3660
<input type="checkbox"/>	Custom Length: _____	

Select Canopy Finish & Power Cord Color

Canopy	Power Cord
<input type="checkbox"/> White	<input type="checkbox"/> White
<input type="checkbox"/> Black	<input type="checkbox"/> Black*
<input type="checkbox"/> Custom Finish	
RAL: _____	

Light Level Performance at 4000K

		OPTICS - UP: Meta Blanc / DOWN: Meta Blanc (MBMB)											
		2700K				4000K				6500K			
		L1	L2	L3	L4	L1	L2	L3	L4	L1	L2	L3	L4
Total Lumens / foot (lm)	80 CRI	626	817	1045	1440	682	856	1154	1649	690	872	1162	1630
	90 CRI	550	718	919	1265	599	752	1014	1450	606	766	1022	1432
Distribution (Up/Down %)		52 / 48											
Wattage per foot		7.0	9.0	12.5	19.5	6.8	8.6	11.8	18.2	7.1	9.1	12.7	20.0
Efficacy (lm/W)	80 CRI	89	91	84	74	100	100	98	91	97	96	91	82
	90 CRI	78	80	74	65	88	88	86	80	85	84	80	72
Color Rendering (CRI)	80 CRI	80+											
	90 CRI	90+											
L70 Reported @ 25°C Ambient		> 60,000 hrs											

Metalumen's light level performance metrics are subject to manufacturers component tolerances.

WIRING

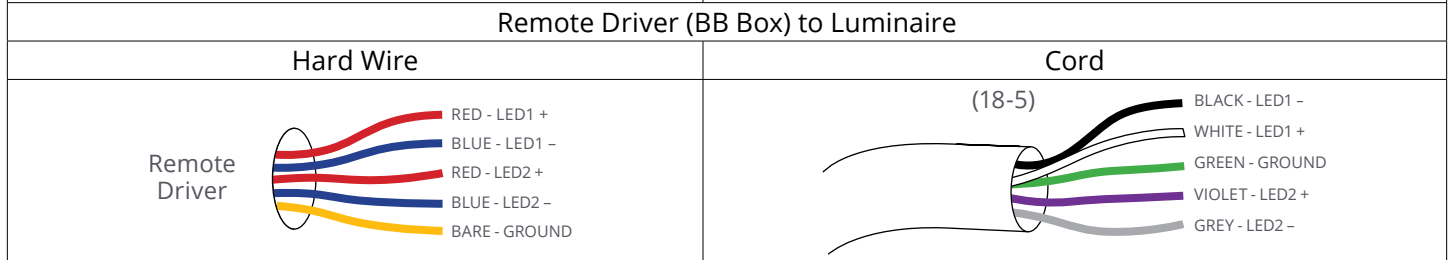
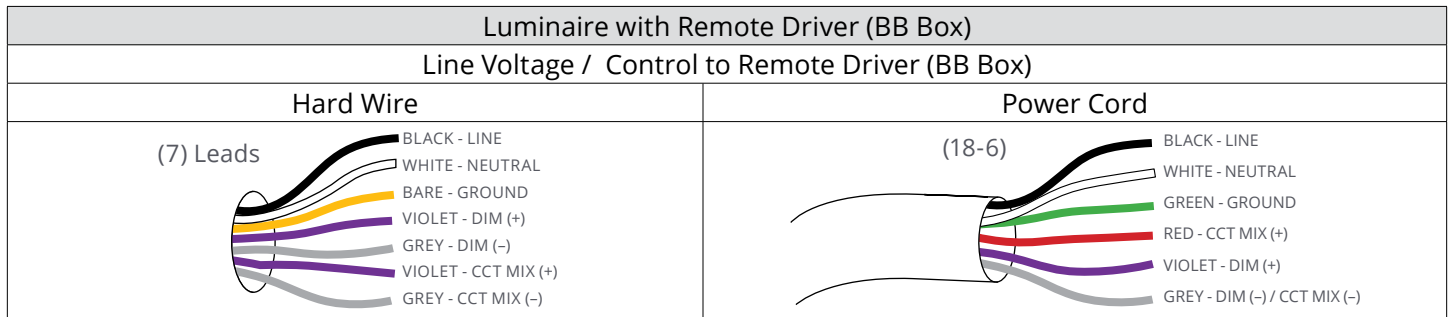
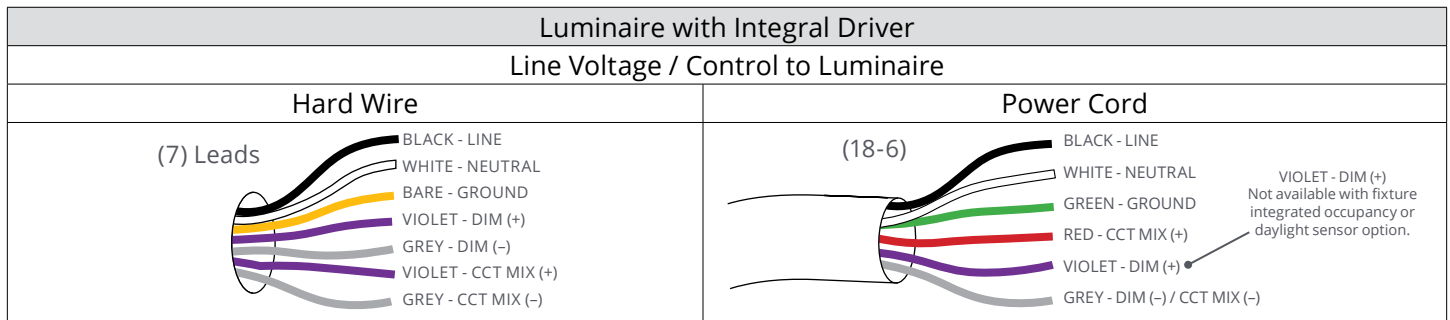
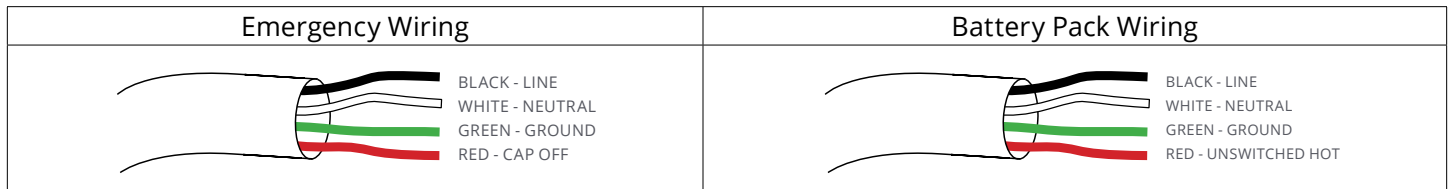

CONTINUOUS ROWS



Step 1) Indicate desired quantity of rows under the QTY column

Step 2)  If applicable, select pod(s) per row to indicate desired Emergency/Night Light/Battery location. If a similar row requires a different Emergency lighting location, please fill out another sheet.

Record drawings for rows not represented here will be sent out upon order.

QTY	Nominal Length	Run Length Overall	Alone / Start Length	Mid Length(s)	End Length	
					ROWS IN PLAN VIEW Rows are for demonstration purposes only and are not to scale.	
	4'	1225 [48.2]	4		1213 [47.8]	
	8'	2442 [96.1]	8		2430 [95.7]	
	12'	3661 [144.1]	12		3650 [143.7]	
	16'	4881 [192.2]	8	8	2430 [95.7] 2438 [96.0]	
	20'	6100 [240.2]	12	8	3650 [143.7] 2438 [96.0]	
	24'	7319 [288.1]	12	12	3650 [143.7] 3658 [144.0]	
	28'	8538 [336.1]	8	12	8	2430 [95.7] 3658 [144.0] 2438 [96.0]
	32'	9757 [384.1]	12	8	12	3650 [143.7] 2438 [96.0] 3658 [144.0]
	36'	10977 [432.2]	12	12	12	3650 [143.7] 3658 [144.0] 3658 [144.0]
	40'	12196 [480.2]	12	8, 8	12	3650 [143.7] 2438 [96.0] 2438 [96.0] 3658 [144.0]
	44'	13415 [528.1]	12	12, 8	12	3650 [143.7] 3658 [144.0] 2438 [96.0] 3658 [144.0]
	48'	14634 [576.1]	12	12, 12	12	3650 [143.7] 3658 [144.0] 3658 [144.0] 3658 [144.0]

LEGEND

-  Standard Wire Entry Location
(located 52mm from end on top of fixture)
-  Emergency (EM) / Night Light / Battery Location
-  EM or Battery Wire Entry Location
(located 52mm from end on top of fixture)

Mounting Points

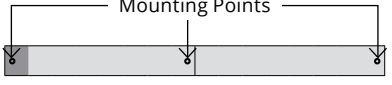

A A



A = Distance Between Mounting Points

EM / Night Light and EM or Battery Wire Entry location in relation to pod selections:

Example 20 ft run



Refer to page 4 for Hanger information

HANGER

Aircraft Cable & Cord

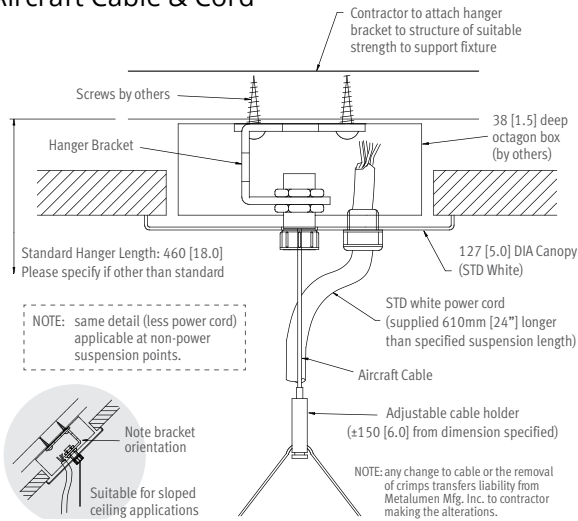

T-Bar Aircraft Cable & Cord

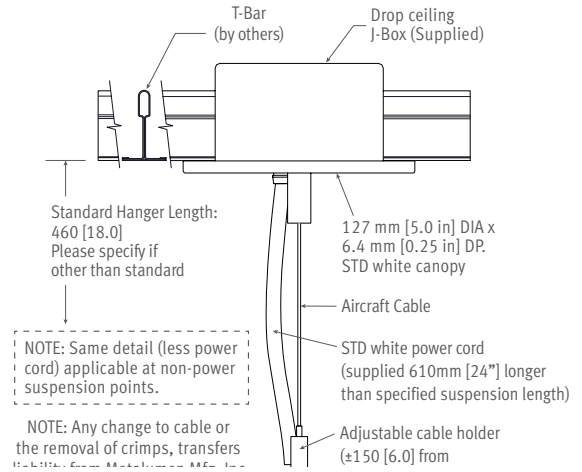

CROSS SECTIONS

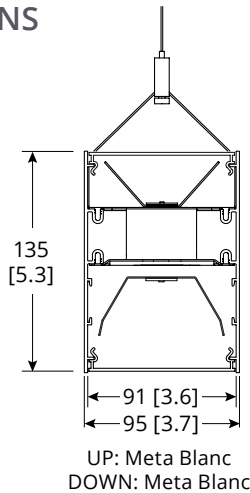

SPECIFICATIONS

Due to the Continuous Improvement Policy at Metalumen, we reserve the right to change our specifications without notice.

Housing: Rigid extruded aluminum body, 2.0mm (0.08") nominal wall thickness. Steel formed end caps.
Optical System: Metalumen luminaires are designed to utilize leading edge LED technology combined with luminaire optimized reflectors and our custom diffusers, resulting in industry leading optical performance.
CRI: 80+ for all color temperature

ranges.
Lumen Maintenance: Minimum 50,000h with TM-21 lumen maintenance of 85% @ 25°C ambient temperature (calculated based on IESNA LM-80-08 LED test data). L70: >60,000hrs.
Finish: Satin aluminum, white and black are standard finishes. For custom finish, contact factory.
Weight: 2.1 kg/300mm [4.6 lb/ft]

Mounting: Aircraft cable yoke complete with a Quick-Grip field adjustable suspension system provides for quick and easy onsite alignment.
Electrical: Factory prewired with easy wire quick connect sections.
Drivers: Metalumen offers 0-10V dimming* as a standard on our entire LED product offering. Dimming range is 1%-100%. Power factor is > 90%. Class

2 rating.
Approvals: All components are UL/CSA/QPS recognized or listed. RoHS compliant.
Environment: Suitable for dry or damp locations.
 *Standard drivers compatible with passive/sinking dimmers. Please contact Metalumen if active/sourcing dimmer support is required.

WARRANTY

Metalumen will warrant defective luminaires for 5 years from date of purchase. Warranty is valid if luminaire is installed and used according to specification. If defective, Metalumen will send replacement boards or drivers at no cost along with detailed replacement instructions and instructions on how to return defective components to Metalumen.