

# RAIL 4 RM4D

LED . RECESSED DRYWALL FLANGELESS . DIRECT

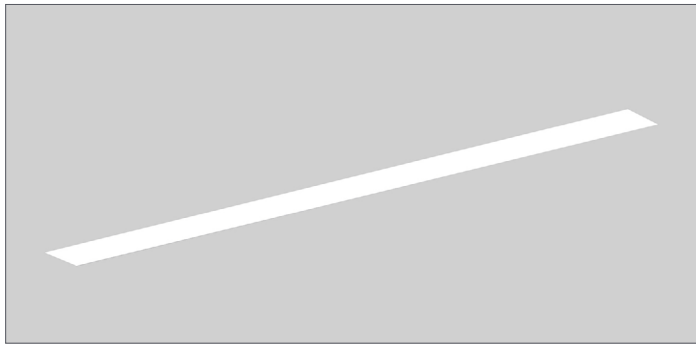

PART #:	
PREP BY:	DATE:
PROJECT:	
NOTES:	
APPROVAL SIGNATURE:	DATE (DD/MM/YYYY):

### PERFORMANCE SUMMARY

		Meta Blanc	Meta Ice	Drop Lens	Meta Asym.
		L3	L3	L3	L3
Lumens per foot	80 CRI	596	662	608	621
	90 CRI	522	579	532	543
Wattage per foot		6.1	6.1	6.1	6.1
Efficacy	80 CRI	99	109	100	103
	90 CRI	85	95	87	102
L70 Estimate (h)		≥ 60,000 hrs			

See page 2 for the complete Light Level Performance chart.

### FEATURES

- 3/4" drop lens with seamless lines of light without pixels or shadows
- Integral drivers
- Option for daylight harvesting, occupancy sensing, dimming control and emergency lighting
- Optional Illuminated by BIOS version for Healthy Lighting and Well Building Applications
- Plenum rated, CCEA approved

### ORDERING LOGIC

Example Part Number: RM4D-1L35K-12-MB-W-L31-DF-1-DW-90

RM4D													DF	
1	2	3	4	5	6	7	8	9	10	11	12	13		
1. SERIES <b>RM4D</b>	2. COLOR TEMP <b>1L30K</b> 3000K <b>1L35K</b> 3500K <b>1L40K</b> 4000K  90 CRI is available under OPTIONS  BIOS is available under OPTIONS. See p2 for BIOS Naming Convention Reference	3. LENGTH <b>2</b> 2 ft <b>3</b> 3 ft <b>4</b> 4 ft <b>5</b> 5 ft <b>6</b> 6 ft <b>7</b> 7 ft <b>8</b> 8 ft <b>9</b> 9 ft <b>10</b> 10 ft <b>11</b> 11 ft <b>12</b> 12 ft <b>RA</b> Continuous Rows Replace "A" with length in feet selected on p3 <b>C</b> Custom Length* - None (leave space empty)	4. PATTERN <sup>1</sup> <b>GA</b> Square <b>GAxB</b> Rectangle <b>UAxBxC</b> U-Shape <b>LAxB</b> L-Shape <b>C</b> Custom Pattern* - None (leave space empty)  <b>Standard Patterns Minimum Lengths</b>  A = 4 ft min, B = 4 ft min.   A = 3 ft min, B = 4 ft min, C = 3 ft min.   A = 3 ft min, B = 3 ft min.  <b>Custom Patterns*</b> Lengths and a drawing of custom pattern are required on page 3  <b>Select corner:</b> <input type="checkbox"/> Outside 90° <input type="checkbox"/> Inside 90°					5. OPTICS <b>MB</b> Meta Blanc <b>M</b> Meta Ice <b>MD</b> Drop Lens ** <b>MA</b> Meta Asymmetric  <b>MB &amp; MD:</b> Opal diffuse lens <b>M &amp; MA:</b> High output semi-diffuse lens	6. FINISH <b>SA</b> Satin Aluminum <b>W</b> White <b>B</b> Black <b>C</b> Custom Finish Specify RAL:					
7. LIGHT LEVEL / DRIVER <b>L1</b> <sup>3</sup> <b>L2</b> <b>L3</b> <b>L4</b>  <b>LX</b> Enter desired lm/ft:	8. CIRCUITRY <b>1</b> 1 Circuit <b>EM</b> Emergency / Night Light <b>B</b> Emergency Battery Pack <sup>2</sup>	9. MOUNTING <b>DF</b> Recessed Drywall Flangeless	10. VOLTAGE <b>1</b> 120 V <b>2</b> 277 V <b>3</b> 347 V <b>4</b> UNV (120 - 277V)	11. SENSORS	12. CONTROLS	13. OPTIONS <b>90</b> 90 CRI, High R9 <b>BS</b> BIOS Static <b>BD</b> BIOS Dynamic - None (leave space empty)								

\*Consult factory. | \*\* Drop lens is not available with patterns. | <sup>1</sup> Pattern approval drawings showing mounting locations will be sent out upon order. | <sup>2</sup> Battery operates 4ft sections only. | <sup>3</sup> Not available with BIOS.

### Select Driver:

- Factory option 0-10V, 1% Dimming
- LHE** Lutron H-Series Hi-lume 1% EcoSystem LED Driver
- LA2** Lutron A-Series Hi-lume 1% 2-wire LED Driver
- L5E** Lutron 5-Series EcoSystem LED Driver

## Light Level Performance

3500K, 80 CRI, 0-10V Dimming (Standard)

Light Level	Meta Blanc (MB)			Meta Ice (M)			Drop Lens (MD)			Meta Asymmetric (MA)		
	Lumens per foot	Wattage per foot	Efficacy (lm/W)	Lumens per foot	Wattage per foot	Efficacy (lm/W)	Lumens per foot	Wattage per foot	Efficacy (lm/W)	Lumens per foot	Wattage per foot	Efficacy (lm/W)
<b>L1</b>	350	3.5	100	389	3.5	111	357	3.5	102	365	3.5	104
<b>L2</b>	439	4.4	99	487	4.4	110	447	4.4	101	458	4.4	104
<b>L3</b>	596	6.1	99	662	6.1	109	608	6.0	101	621	6.1	103
<b>L4</b>	1106	12.5	89	1232	12.5	99	1127	12.5	90	1155	12.5	93

## Lumen Adjustment Factor (Standard)

Color Temp	80 CRI	90 CRI
3000K	0.984	0.880
3500K	1.000	0.875
4000K	1.032	0.879

## BIOS 3500K

	Meta Blanc (MB)			Meta Ice (M)			Drop Lens (MD)			Meta Asymmetric (MA)			
	Lumens per foot	Wattage per foot	Efficacy (lm/W)	Lumens per foot	Wattage per foot	Efficacy (lm/W)	Lumens per foot	Wattage per foot	Efficacy (lm/W)	Lumens per foot	Wattage per foot	Efficacy (lm/W)	
Distribution % (Up/Down)	0 / 100			0 / 100			6 / 94			0 / 100			
Static	L2	590	9.4	63	656	9.4	70	622	9.4	66	643	9.4	68
	L3	787	13.3	59	875	13.3	66	829	13.3	62	858	13.3	64
	L4	957	17.2	56	1063	17.2	62	1007	17.2	59	957	17.2	56
Dynamic	L2	531	9.4	56	590	9.4	63	559	9.4	59	578	9.4	61
	L3	708	13.3	53	787	13.3	59	746	13.3	56	772	13.3	58
	L4	861	17.2	50	957	17.2	56	907	17.2	53	861	17.2	50
R9	≥ 90												
COI**	< 3.3												
EML or M/P*	0.8												

\* EML or M/P is a ratio that describes the relative melanopic lux (M) versus the photopic lux (P). BIOS provides the following m/p values: 3000K = 0.7, 3500K = 0.8, 4000K = 0.9. \*\* COI - Cyanosis Observation Index.

## BIOS Naming Convention Reference

BIOS	Static	
	3500K	35BIOSST
BIOS	4000K	40BIOSST
	Dynamic	
BIOS	3500K	35BIOSDY
	4000K	40BIOSDY

## BIOS | Lumen Adjustment Factor (LAF)

Color Temp	LAF
3500K	1.00
4000K	1.05

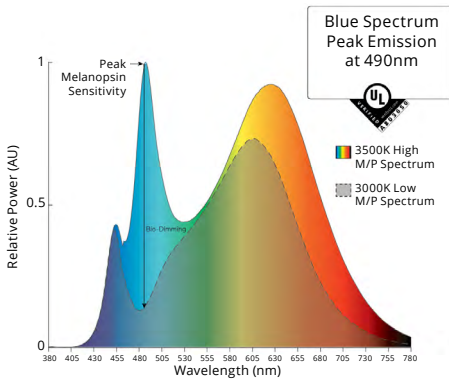











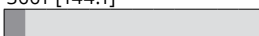

Metalumen's light level performance metrics are subject to manufacturers component tolerances.

### CONTINUOUS ROWS



Step 1) Indicate desired quantity of rows under the QTY column

Step 2)  If applicable, select pod(s) per row to indicate desired emergency lighting / night light / battery location. If a similar row requires a different Emergency lighting location, please fill out another sheet.

Record drawings for rows not represented here will be sent out upon order.

QTY	Nominal Length	Max. Recommended Length Drywall Opening (Max. Rec. Width = 105mm)	Mid Length(s)			End Length	ROWS IN PLAN VIEW Rows are for demonstration purposes only and are not to scale.
			Alone / Start Length				
	4'	1235 [48.6]	4			1225 [48.2]	
	8'	2452 [96.5]	8			2442 [96.1]	
	12'	3671 [144.5]	12			3661 [144.1]	
	16'	4891 [192.6]	8		8	4881 [192.2]	
	20'	6110 [240.6]	12		8	6100 [240.2]	
	24'	7329 [288.5]	12		12	7319 [288.1]	
	28'	8548 [336.5]	8	12	8	8538 [336.1]	
	32'	9767 [384.5]	12	8	12	9757 [384.1]	
	36'	10987 [432.6]	12	12	12	10977 [432.2]	
	40'	12206 [480.6]	12	8, 8	12	12196 [480.2]	
	44'	13425 [528.5]	12	12, 8	12	13415 [528.1]	
	48'	14644 [576.5]	12	12, 12	12	14634 [576.1]	

#### LEGEND

-  Standard (STD) Wire Entry Location (located 52mm from end on top of fixture)
-  Emergency (EM) / Night Light Location (4 ft sections)
-  EM or Battery Wire Entry Location (located 52mm from end on top of fixture)

---

**A**  A = Run Length (Body)

---

EM / Night Light and EM or Battery Wire Entry location in relation to pod selections:

Example 20 ft run

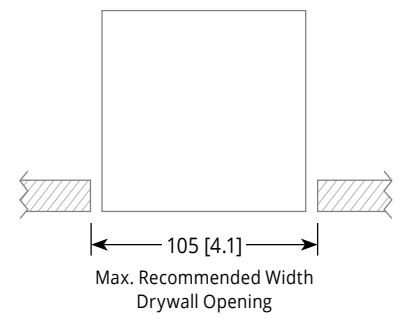

PATTERNS

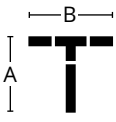
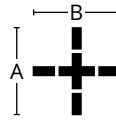
Select Pattern:	<input type="checkbox"/> T-SHAPE (C)	<input type="checkbox"/> CROSS / X-SHAPE (C)
Pattern Configuration		
Indicate Desired Lengths (ft)	A = B =	A = B =
Minimum Lengths	A = 3 ft B = 6 ft	A = 6 ft B = 6 ft

**A custom pattern configuration drawing is required in the grid below**

Approval drawings will be sent out upon order showing mounting locations.

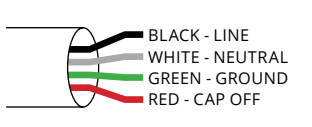
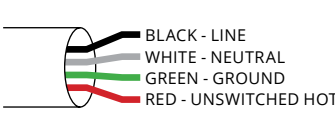

WIRING

Standard	Emergency / Night Light	Emergency Battery Pack
 <p>BLACK - LINE                  WHITE - NEUTRAL                  GREEN - GROUND                  RED - CAPPED/SW LEAD                  VIOLET - DIM(+)                  PINK - DIM(-)</p>	 <p>BLACK - LINE                  WHITE - NEUTRAL                  GREEN - GROUND                  RED - CAP OFF</p>	 <p>BLACK - LINE                  WHITE - NEUTRAL                  GREEN - GROUND                  RED - UNSWITCHED HOT</p>

CROSS SECTIONS

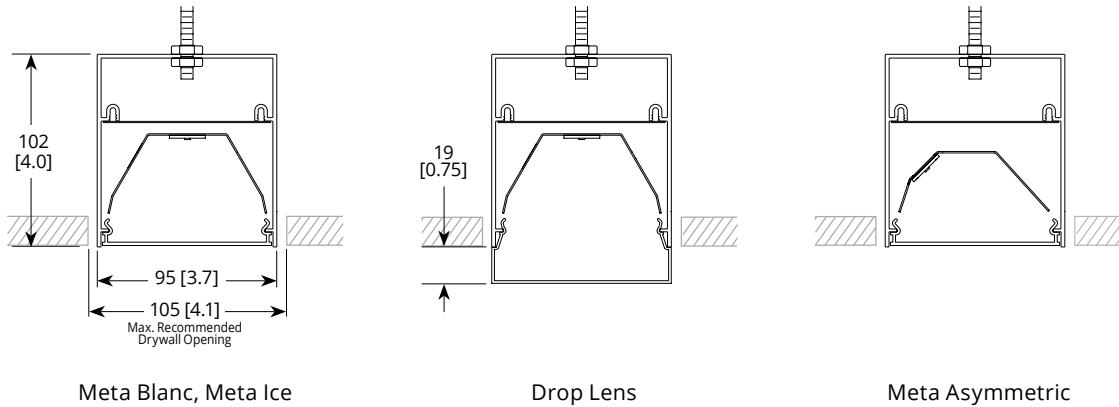

SPECIFICATIONS

Due to the Continuous Improvement Policy at Metalumen, we reserve the right to change our specifications without notice.

**Housing:** Rigid extruded aluminum body, 2.0mm (0.08”) nominal wall thickness. Aluminum end caps.

**Optical System:** Metalumen luminaires are designed to utilize leading edge LED technology combined with luminaire optimized reflectors and our custom diffusers, resulting in industry leading optical performance.

**BIOS LED:** BIOS SkyBlue® solutions have a peak wavelength at 490nm to provide an enhanced spectrum with high M/P (melanopic to photopic)

ratios while also providing a low Cyanosis Observation Index (COI), making it ideally suited for Healthcare and Healthy Lighting projects. BIOS® SkyBlue® lighting solutions also contribute to satisfying Circadian Lighting Design Feature for WELL Building Standard v1 and v2.

**CRI:** 83+ for 3500K, 80 minimum for all CCTs in standard configurations.

**Lumen Maintenance:** Minimum 50,000h with TM-21 lumen maintenance of 85% @ 25°C ambient temperature (calculated based on

IESNA LM-80-08 LED test data). L70: ≥60,000hrs.

**Finish:** Satin aluminum, white and black are standard finishes. For custom finish, contact factory.

**Weight:** 1.3 kg/300 mm [2.9 lb/ft]

**Mounting:** Mounting brackets provided.

**Electrical:** Factory prewired with easy wire quick connect sections.

**Drivers:** Metalumen offers 0-10V dimming\* as a standard on our entire LED product offering. Dimming range is 1%-100%. Power factor is > 90%. Class

2 rating. Drivers are integral.

**Approvals:** All components are UL/CSA/QPS recognized or listed. RoHS compliant. This product is cULus listed. Plenum - CCEA approved.

**Environment:** Suitable for dry or damp locations.

*\*Standard drivers compatible with passive/sinking dimmers. Please contact Metalumen if active/sourcing dimmer support is required.*

WARRANTY

Metalumen will warrant defective luminaires for 5 years from date of purchase. Warranty is valid if luminaire is installed and used according to specification. If defective, Metalumen will send replacement boards or drivers at no cost along with detailed replacement instructions and instructions on how to return defective components to Metalumen.

PHOTOMETRIC DATA - 3500K, 80 CRI

Optics: **Meta Blanc**  
 IES File: **RM4D-1L35K-4-MB-L3**  
 Lumens: **596/ft** Wattage: **6.1/ft**  
 Efficacy: **99 lm/W**

ZONAL LUMEN SUMMARY

Zone	Lumens	%Fixt
0-90	2386	100
90-180	0	0
0-180	2386	100

LUMINANCE DATA (CD/M2)

Vertical Angle	Horizontal Angle		
	0	45	90
45	6758	3654	2909
55	5592	2577	1949
65	4364	1635	1211
75	2843	811	552
85	1181	181	131

PHOTOMETRIC CURVE

100% Down

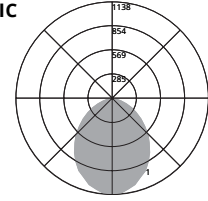

Optics: **Meta Ice**  
 IES File: **RM4D-1L35K-4-M-L3**  
 Lumens: **662/ft** Wattage: **6.1/ft**  
 Efficacy: **109 lm/W**

ZONAL LUMEN SUMMARY

Zone	Lumens	%Fixt
0-90	2649	100
90-180	0	0
0-180	2649	100

LUMINANCE DATA (CD/M2)

Vertical Angle	Horizontal Angle		
	0	45	90
45	7275	4112	3367
55	6142	2892	2261
65	4764	1861	1381
75	3194	909	647
85	1318	208	144

PHOTOMETRIC CURVE

100% Down

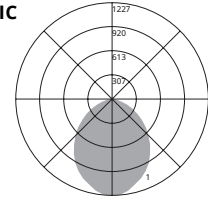

Optics: **Drop Lens**  
 IES File: **RM4D-1L35K-4-MD-L3**  
 Lumens: **608/ft** Wattage: **6.1/ft**  
 Efficacy: **100 lm/W**

ZONAL LUMEN SUMMARY

Zone	Lumens	%Fixt
0-90	2296	94.4
90-180	137	5.60
0-180	2434	100

LUMINANCE DATA (CD/M2)

Vertical Angle	Horizontal Angle		
	0	45	90
45	5864	3072	2506
55	4860	2210	1834
65	3633	1532	1281
75	2412	953	839
85	1032	520	520

PHOTOMETRIC CURVE

6% Up  
94% Down

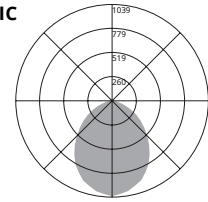

Optics: **Meta Asymmetric**  
 IES File: **RM4D-1L35K-4-MA-L3**  
 Lumens: **621/ft** Wattage: **6.1/ft**  
 Efficacy: **103**

ZONAL LUMEN SUMMARY

Zone	Lumens	%Fixt
0-90	2483	100
90-180	0	0
0-180	2483	100

LUMINANCE DATA (CD/M2)

Vertical Angle	Horizontal Angle		
	0	45	90
45	4213	4695	6641
55	2927	3423	5649
65	1794	2225	4531
75	869	1096	3066
85	157	239	1237

PHOTOMETRIC CURVE

100% Down

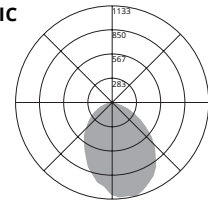

Photometric performance is measured and scaled in accordance with IESNA LM-79.

SENSORS AND CONTROLS



Metalumen offers intelligent standalone and/or connected luminaires with various integrated sensing and control system\* connectivity options. The table below outlines some of the more common combinations and solutions offered. If you do not see the controls solution or the type of sensing technology you require for your project please contact us and we will work with you to try and identify a solution to meet your needs.

\*Control system, installation and commissioning provided by others.

Examples:

WattStopper Daylight Sensor Standalone Luminaire: RM4D-1L35K-12-MB-W-L31-DF-1-DW-90

Occupancy Sensor with Casambi Wireless Bluetooth Mesh Control Capability: RM4D-1L35K-12-MB-W-L31-DF-1-O-CAB-90

ORDER LOGIC FIELDS		SENSOR FEATURE / BEHAVIOR		LUMINAIRE CONTROL / CONNECTIVITY	DESCRIPTION
11. SENSORS	12. CONTROLS	OCCUPANCY (PIR)	DAYLIGHT HARVESTING		
OF	-		None	Standalone	Factory Sensor - Occupancy Behaviors configured via BLE App
OW	-		None	Standalone (WattStopper)	Wattstopper Standalone Occupancy Sensor
DW	-	None		Standalone (WattStopper)	Wattstopper Standalone Daylight Harvesting Sensor
ODW	-			Standalone (WattStopper)	Wattstopper Standalone Occupancy and Daylight Harvesting Sensors
O	- CAB		None	Casambi Bluetooth Mesh	Casambi Bluetooth Mesh Connectivity with Occupancy Sensing
OD	- CAB			Casambi Bluetooth Mesh	Casambi Bluetooth Mesh Connectivity with Daylight Harvesting and Occupancy Sensing
	- CAB	None	None	Casambi Bluetooth Mesh	Casambi Bluetooth Mesh Connectivity (no sensors)
O	- SLVR		None	Silvair Bluetooth Mesh	Open Standard Bluetooth Mesh Connectivity with Occupancy Sensing
OD	- SLVR			Silvair Bluetooth Mesh	Open Standard Bluetooth Mesh Connectivity with Daylight Harvesting and Occupancy Sensing
	- SLVR	None	None	Silvair Bluetooth Mesh	Open Standard Bluetooth Mesh Connectivity (no sensors)
	- OSRM	None	None	Osram Enceium	Osram Enceium connectivity
OD	- OSRM			Osram Enceium	Osram SensiLum Connectivity for Enceium with Occupancy and Daylight Harvesting
OD	- ENL			Enlighted ONE	Occupancy and Daylight Harvesting Capable Supports EnlightedONE room control as well and upgrade path for Enlighted Connected and Enlighted IoT offering advanced applications, analytics and insights for Space Utilization/Optimization, Asset Tracking, Energy Monitoring, HVAC Integration etc..
	- DALI	None	None	DALI addressable wired Luminaire	Generic DALI addressable luminaire
	- ECOS	None	None	Lutron Ecosystem	Lutron Ecosystem addressable wired luminaire NOTE: See Driver Selection options for specific driver

