

RAIL 4 RM4D

LED . RECESSED T-BAR . DIRECT



- 3/4" drop lens with seamless lines of light without pixels or shadows
- Integral drivers
- Option for daylight harvesting, occupancy sensing, dimming control and emergency lighting



PART #:	
PREP BY:	DATE:
PROJECT:	QTY:
NOTES:	
APPROVAL SIGNATURE:	DATE (DD/MM/YYYY):

PERFORMANCE SUMMARY

	Meta Blanc	Meta Ice	Drop Lens	Luma Span	Luma Asym.
	L3	L3	L3	L3	L3
Lumens per foot	80 CRI	596	662	608	697
	90 CRI	522	579	532	609
Wattage per foot	6.1	6.1	6.1	5.8	5.8
Efficacy	80 CRI	99	109	100	121
	90 CRI	85	95	87	105
L70 Estimate (h)	≥ 60,000 hrs				

See complete Light Level Performance and Photometric Data on p2

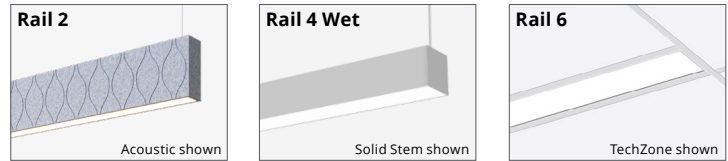

ORDERING LOGIC

Example Part Number: RM4D-1L35K-12-MB-W-L31-T-1-DW-90

RM4D									T				
1	2	3	4	5	6	7	8	9	10	11	12	13	

1. SERIES RM4D	2. COLOR TEMP 1L30K 3000K 1L35K 3500K 1L40K 4000K 90 CRI is available under OPTIONS BIOS is available under OPTIONS. See p2 for BIOS Naming Convention Reference	3. LENGTH 2 2 ft 3 3 ft 4 4 ft 5 5 ft 6 6 ft 7 7 ft 8 8 ft 9 9 ft 10 10 ft 11 11 ft 12 12 ft RA Continuous Rows Replace "A" with length in feet selected on p3 C Custom Length* - None (leave space empty)	4. PATTERN ¹ GA Square GAxB Rectangle UAxBxC U-Shape LAxB L-Shape C Custom Pattern* - None (leave space empty) Standard Patterns Minimum Lengths Square: A = 4 ft min. Rectangle: A = 4 ft min., B = 4 ft min. U-Shape: A = 3 ft min., B = 4 ft min., C = 3 ft min. L-Shape: A = 3 ft min., B = 3 ft min. Custom Patterns* Lengths and a drawing of custom pattern are required on page 3 T-Shape Cross/X Replace "A", "B", "C" with length in feet. See minimum lengths below Select corner: <input type="checkbox"/> Outside 90° <input type="checkbox"/> Inside 90°	5. OPTICS MB Meta Blanc M Meta Ice MD Drop Lens** LS Luma Span (Batwing) LA Luma Asymmetric MB, MD: Opal diffuse lens M, LS, LA: High output semi-diffuse lens See Photometric Data on p2	6. FINISH SA Satin Aluminum W White B Black C Custom Finish Specify RAL:	
7. LIGHT LEVEL / DRIVER L1³ L2 L3 L4 LX Enter desired lm/ft:	8. CIRCUITRY 1 1 Circuit EM Emergency / Night Light B Emergency Battery Pack ²	9. MOUNTING T Recessed T-Bar	10. VOLTAGE 1 120V 2 277V 3 347V 4 UNV (120 - 277V)	11. SENSORS Please see last page for fixture integrated SENSORS and CONTROLS Order Logic codes	12. CONTROLS	13. OPTIONS 90 90 CRI, High R9 BS BIOS Static BD BIOS Dynamic - None (leave space empty)

*Consult factory. | ** Drop lens is not available with patterns. | ¹ Pattern record drawings showing mounting locations will be sent out upon order. | ² Battery operates 4ft sections only. | ³ Not available with BIOS.

- Select Driver: Factory option 0-10V, 1% Dimming
 LHE Lutron H-Series Hi-Lume 1% EcoSystem LED Driver
 LSE Lutron S-Series EcoSystem LED Driver

LIGHT LEVEL PERFORMANCE & PHOTOMETRIC DATA

3500K, 80 CRI, 0-10V Dimming (Standard)

Light Level	Meta Blanc (MB)			Meta Ice (M)			Drop Lens (MD)			Luma Span (LS)			Luma Asymmetric (LA)			
	Lumens per foot	Wattage per foot	Efficacy (LPW)	Lumens per foot	Wattage per foot	Efficacy (LPW)	Lumens per foot	Wattage per foot	Efficacy (LPW)	Lumens per foot	Wattage per foot	Efficacy (LPW)	Lumens per foot	Wattage per foot	Efficacy (LPW)	
L1	350	3.5	100	389	3.5	111	357	3.5	102	417	3.3	126	432	3.3	131	
L2	439	4.4	99	487	4.4	110	447	4.4	101	521	4.3	121	539	4.3	125	
L3	596	6.1	99	662	6.1	109	608	6.0	101	697	5.8	121	723	5.8	125	
L4	1106	12.5	89	1232	12.5	99	1127	12.5	90	1277	11.9	108	1325	11.9	112	
Light Level L3	IES File	RM4D-1L35K-4-MB-L3			RM4D-1L35K-4-M-L3			RM4D-1L35K-4-MD-L3			RM4D-1L35K-4-LS-L3			RM4D-1L35K-4-LA-L3		
	Distribution % (Down / Up)	100 / 0			100 / 0			94 / 6			100 / 0			100 / 0		
	Zonal Lumens (0-90 / 90-180)	2386 / 0			2649 / 0			2296 / 137			2787 / 0			2892 / 0		
	Distribution Curve															

Lumen Adjustment Factor (Standard)

Color Temp	80 CRI	90 CRI
3000K	0.984	0.880
3500K	1.000	0.875
4000K	1.032	0.879

BIOS PERFORMANCE

3500K

		Meta Blanc (MB)			Meta Ice (M)			Drop Lens (MD)		
		Lumens per foot	Wattage per foot	Efficacy (LPW)	Lumens per foot	Wattage per foot	Efficacy (LPW)	Lumens per foot	Wattage per foot	Efficacy (LPW)
Distribution % (Up/Down)		0 / 100			0 / 100			6 / 94		
Static	L2	590	9.4	63	656	9.4	70	622	9.4	66
	L3	787	13.3	59	875	13.3	66	829	13.3	62
	L4	957	17.2	56	1063	17.2	62	1007	17.2	59
Dynamic	L2	531	9.4	56	590	9.4	63	559	9.4	59
	L3	708	13.3	53	787	13.3	59	746	13.3	56
	L4	861	17.2	50	957	17.2	56	907	17.2	53
R9		≥ 90								
COI**		< 3.3								
EML or M/P*		0.8								

* EML or M/P is a ratio that describes the relative melanopic lux (M) versus the photopic lux (P). BIOS provides the following m/p values: 3000K = 0.7, 3500K = 0.8, 4000K = 0.9. ** COI - Cyanosis Observation Index.

BIOS Naming Convention Reference

BIOS	Static	
	3500K	35BIOSST
4000K	40BIOSST	
BIOS	Dynamic	
	3500K	35BIOSDY
4000K	40BIOSDY	

BIOS | Lumen Adjustment Factor (LAF)

Color Temp	LAF
3500K	1.00
4000K	1.05

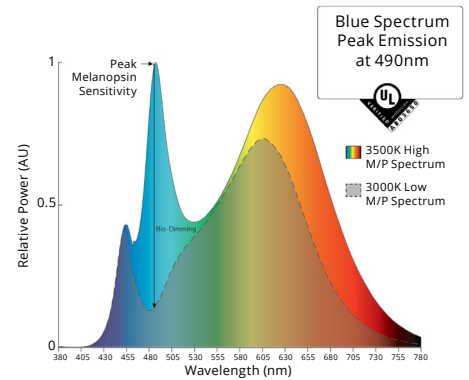

Metalumen's light level performance metrics are subject to manufacturers component tolerances.

CONTINUOUS ROWS

Step 1) Indicate desired quantity of rows under the QTY column

Step 2) ← Pods → If applicable, select pod(s) per row to indicate desired emergency lighting / night light / battery location. If a similar row requires a different Emergency lighting location, please fill out another sheet.

Record drawings for rows not represented here will be sent out upon order.

QTY	Nominal Length	Run Length Overall	Alone / Start Length	Mid Length(s)	End Length	ROWS IN PLAN VIEW Rows are for demonstration purposes only and are not to scale.
	4'	For 4' T-bar Centers	4			1209 [47.6]
	8'	For 8' T-bar Centers	8			2428 [95.6]
	12'	For 12' T-bar Centers	12			3648 [143.6]
	16'	For 16' T-bar Centers	8		8	4867 [191.6]
	20'	For 20' T-bar Centers	12		8	6086 [238.9]
	24'	For 24' T-bar Centers	12		12	7305 [287.6]
	28'	For 28' T-bar Centers	8	12	8	8524 [335.6]
	32'	For 32' T-bar Centers	12	8	12	9744 [383.6]
	36'	For 36' T-bar Centers	12	12	12	10963 [431.6]
	40'	For 40' T-bar Centers	12	8, 8	12	12182 [479.6]
	44'	For 44' T-bar Centers	12	12, 8	12	13401 [527.6]
	48'	For 48' T-bar Centers	12	12, 12	12	14620 [575.6]

LEGEND

- Standard (STD) Wire Entry Location (located on the end cap)
- Emergency (EM) / Night Light Location (4 ft sections)
- EM or Battery Wire Entry Location (EM wire entry is on the end cap)

A

A = Run Length (Body)

EM / Night Light and EM or Battery Wire Entry location in relation to pod selections:

Example 20 ft run

✓

✓

PATTERNS

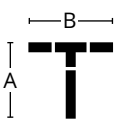
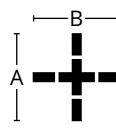

Select Pattern:	<input type="checkbox"/> T-SHAPE (C)	<input type="checkbox"/> CROSS / X-SHAPE (C)
Pattern Configuration		
Indicate Desired Lengths (ft)	A = B =	A = B =
Minimum Lengths	A = 3 ft B = 6 ft	A = 6 ft B = 6 ft

A custom pattern configuration drawing is required in the grid below

Approval drawings will be sent out upon order showing mounting locations.



WIRING

Standard	Emergency / Night Light	Emergency Battery Pack
 <p>BLACK - LINE WHITE - NEUTRAL GREEN - GROUND RED - CAPPED/SW LEAD VIOLET - DIM(+) PINK - DIM(-)</p>	 <p>BLACK - LINE WHITE - NEUTRAL GREEN - GROUND RED - CAP OFF</p>	 <p>BLACK - LINE WHITE - NEUTRAL GREEN - GROUND RED - UNSWITCHED HOT</p>

CROSS SECTIONS

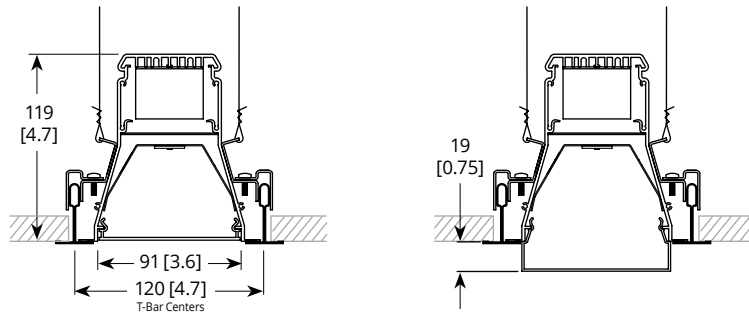

Meta Blanc, Meta Ice,
Luma Span, Luma Asymmetric

Drop Lens

SPECIFICATIONS

Due to the Continuous Improvement Policy at Metalumen, we reserve the right to change our specifications without notice.

Housing: Rigid extruded aluminum body, 2.0mm (0.08") nominal wall thickness. Zinc alloy die-cast end caps.

Optical System: Metalumen luminaires are designed to utilize leading edge LED technology combined with luminaire optimized reflectors and our custom diffusers, resulting in industry leading optical performance.

BIOS LED: BIOS SkyBlue® solutions have a peak wavelength at 490nm to provide an enhanced spectrum with high M/P (melanopic to photopic)

ratios while also providing a low Cyanosis Observation Index (COI), making it ideally suited for Healthcare and Healthy Lighting projects. BIOS® SkyBlue® lighting solutions also contribute to satisfying Circadian Lighting Design Feature for WELL Building Standard v1 and v2.

CRI: 83+ for 3500K, 80 minimum for all CCTs in standard configurations.

Lumen Maintenance: Minimum 50,000h with TM-21 lumen maintenance of 85% @ 25°C ambient temperature (calculated based on

IESNA LM-80-08 LED test data). L70: ≥60,000hrs.

Finish: Satin aluminum and white are standard finishes. For custom finish, contact factory.

Weight: 1.3 kg/300 mm [2.9 lb/ft]

Mounting: Mounting brackets/clips provided. Fits 9/16" and 15/16" T-bar.

Electrical: Factory prewired with easy wire quick connect sections.

Drivers: Metalumen offers 0-10V dimming* as a standard on our entire LED product offering. Dimming range is 1%-100%. Power factor is > 90%. Class

2 rating. Drivers are integral.

Approvals: All components are UL/CSA/QPS recognized or listed. RoHS compliant. This product is cULus listed. Plenum - CCEA approved.

Environment: Suitable for dry or damp locations.

**Standard drivers compatible with passive/sinking dimmers. Please contact Metalumen if active/sourcing dimmer support is required.*

WARRANTY

Metalumen will warrant defective luminaires for 5 years from date of purchase. Warranty is valid if luminaire is installed and used according to specification. If defective, Metalumen will send replacement boards or drivers at no cost along with detailed replacement instructions and instructions on how to return defective components to Metalumen.

SENSORS AND CONTROLS



Metalumen offers intelligent standalone and/or connected luminaires with various integrated sensing and control system* connectivity options. The table below outlines some of the more common combinations and solutions offered. If you do not see the controls solution or the type of sensing technology you require for your project please contact us and we will work with you to try and identify a solution to meet your needs.

*Control system, installation and commissioning provided by others.

Examples:

WattStopper Daylight Sensor Standalone Luminaire: RM4D-1L35K-12-MB-W-L31-T-1-DW-90

Occupancy Sensor with Casambi Wireless Bluetooth Mesh Control Capability: RM4D-1L35K-12-MB-W-L31-T-1-O-CAB-90

ORDER LOGIC FIELDS		SENSOR FEATURE / BEHAVIOR		LUMINAIRE CONTROL / CONNECTIVITY	DESCRIPTION
11. SENSORS	12. CONTROLS	OCCUPANCY (PIR)	DAYLIGHT HARVESTING		
OF	-		None	Standalone	Factory Sensor - Occupancy Behaviors configured via BLE App
OW	-		None	Standalone (WattStopper)	Wattstopper Standalone Occupancy Sensor
DW	-	None		Standalone (WattStopper)	Wattstopper Standalone Daylight Harvesting Sensor
ODW	-			Standalone (WattStopper)	Wattstopper Standalone Occupancy and Daylight Harvesting Sensors
O	- CAB		None	Casambi Bluetooth Mesh	Casambi Bluetooth Mesh Connectivity with Occupancy Sensing
OD	- CAB			Casambi Bluetooth Mesh	Casambi Bluetooth Mesh Connectivity with Daylight Harvesting and Occupancy Sensing
	- CAB	None	None	Casambi Bluetooth Mesh	Casambi Bluetooth Mesh Connectivity (no sensors)
O	- SLVR		None	Silvair Bluetooth Mesh	Open Standard Bluetooth Mesh Connectivity with Occupancy Sensing
OD	- SLVR			Silvair Bluetooth Mesh	Open Standard Bluetooth Mesh Connectivity with Daylight Harvesting and Occupancy Sensing
	- SLVR	None	None	Silvair Bluetooth Mesh	Open Standard Bluetooth Mesh Connectivity (no sensors)
	- OSRM	None	None	Osram Enceium	Osram Enceium connectivity
OD	- OSRM			Osram Enceium	Osram SensiLum Connectivity for Enceium with Occupancy and Daylight Harvesting
OD	- ENL			Enlighted ONE	Occupancy and Daylight Harvesting Capable Supports EnlightedONE room control as well and upgrade path for Enlighted Connected and Enlighted IoT offering advanced applications, analytics and insights for Space Utilization/Optimization, Asset Tracking, Energy Monitoring, HVAC Integration etc..
	- DALI	None	None	DALI addressable wired Luminaire	Generic DALI addressable luminaire
	- ECOS	None	None	Lutron Ecosystem	Lutron Ecosystem addressable wired luminaire NOTE: See Driver Selection options for specific driver

