

# RAIL 4 RM4D

TUNABLE . RECESSED DRYWALL FLANGELESS . DIRECT

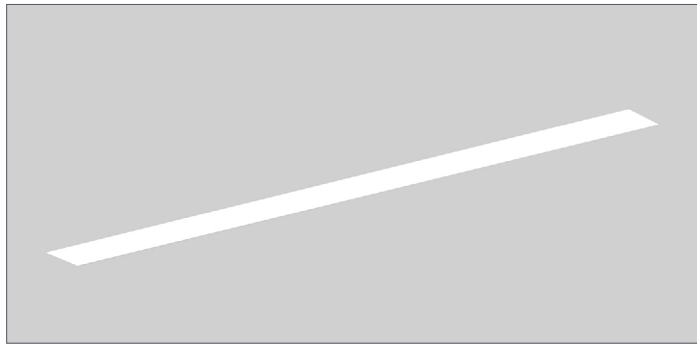

PART #:	
PREP BY:	DATE:
PROJECT:	
NOTES:	
APPROVAL SIGNATURE:	DATE (DD/MM/YYYY):

PERFORMANCE SUMMARY @ 4000K

		Meta Blanc (MB)	Drop Lens (MD)
		L3	L3
Lumens per foot	80 CRI	547	577
	90 CRI	481	507
Wattage per foot		6.2	
Efficacy	80 CRI	88	93
	90 CRI	77	81
L70 Estimate (h)		>60,000 hrs	

See page 2 for the complete Light Level Performance chart.

## FEATURES

- Independent control of intensity and correlated color temperature (CCT)
- Allows for scheduled mimicking of daylight color temperatures
- Dim-to-Warm simulates warmer CCT shift as luminaire dims (i.e. like traditional incandescent and halogen lights).

## ORDERING LOGIC

Example Part Number: RM4D-1LTUN-12-MB-W-L31-DF-1-D-90

RM4D											
1	2	3	4	5	6	7	8	9	10	11	
<b>1. SERIES</b> RM4D	<b>2. COLOR TEMP</b> 1LTUN Tunable White (2700 - 6500K) 1LDW Dim to Warm* (3500 - 2700K)  CRI 90 is available under OPTIONS	<b>3. LENGTH</b> 2 2 ft 3 3 ft 4 4 ft 5 5 ft 6 6 ft 7 7 ft 8 8 ft 9 9 ft 10 10 ft 11 11 ft 12 12 ft RA Continuous Rows Replace "A" with length in feet selected on the CONTINUOUS ROWS page				<b>4. OPTICS</b> MB Meta Blanc MD Drop Lens  Meta Blanc, Drop Lens: Opal diffuse lens		<b>5. FINISH</b> SA Satin Aluminum W White B Black C Custom Finish Specify RAL:		<b>6. LIGHT LEVEL / DRIVER</b> L1 Select Driver below. L2 See Light Level Performance chart on p2. L3 L4	
<b>7. CIRCUITRY</b> 1 1 Circuit EM Emergency / Night Light <sup>1</sup> B Emergency Battery Pack <sup>2</sup>		<b>8. MOUNTING</b> DF Recessed Drywall Flangeless		<b>9. VOLTAGE</b> 1 120V 2 277V 4 UNV (120 - 277V)		<b>10. CONTROLS / SENSORS</b> _ None (leave space empty) D Daylight Sensor** O Occupancy Sensor** DO Daylight and Occupancy Sensor**			<b>11. OPTIONS</b> 90 90 CRI, High R9 P Plenum _ None (leave space empty)		

**PLEASE NOTE** Dim to Warm is not available with integrated sensors.  
Tunable White and Dim to Warm are available with emergency battery packs connected to the cool color LEDs only.

\* Consult factory for alternate range options. | \*\* Controls intensity only (not CCT). | <sup>1</sup> Each EM pod, by default, has separate wire entry for DIM and CCT control. | <sup>2</sup> Battery operates 4ft sections only.

### Select Driver:

- Factory option dual 0-10V (Dim & CCT), 1% Dimming
- Lutron T Series EcoSystem, 1% Dimming
- DALI - Factory Option, DT6 Dual Address, 1% Dimming
- DALI - Factory Option, DT8 Single Address Color Control, 1% Dimming
- DALI - EidoLED

Light Level Performance at 4000K

Meta Blanc (MB)		2700K				4000K				6500K			
		L1	L2	L3	L4	L1	L2	L3	L4	L1	L2	L3	L4
Total Lumens / foot (lm)	80 CRI	297	374	502	694	323	407	547	789	327	411	551	779
0% Up / 100% Down	90 CRI	261	329	441	610	284	358	481	693	287	361	484	685
Wattage per foot		3.9	4.8	6.5	9.7	3.8	4.7	6.2	9.1	3.9	4.9	6.6	10.1
Efficacy (lm/W)	80 CRI	77	78	77	72	84	87	88	86	83	84	83	77
	90 CRI	67	68	68	63	74	76	77	76	73	74	73	68
Color Rendering (CRI)	80 CRI	80+											
	90 CRI	90+											
L70 Estimate @ 25°C Ambient		> 60,000 hrs											

Drop Lens (MD)		2700K				4000K				6500K			
		L1	L2	L3	L4	L1	L2	L3	L4	L1	L2	L3	L4
Total Lumens / foot (lm)	80 CRI	314	395	527	731	341	429	577	830	346	434	578	813
8% Up / 92% Down	90 CRI	276	347	463	643	300	377	507	729	304	381	508	715
Wattage per foot		3.9	4.8	6.5	9.7	3.8	4.7	6.2	9.1	3.9	4.9	6.6	10.1
Efficacy (lm/W)	80 CRI	81	82	81	76	89	92	93	91	88	89	87	81
	90 CRI	71	72	71	66	78	81	81	80	77	78	77	71
Color Rendering (CRI)	80 CRI	80+											
	90 CRI	90+											
L70 Estimate @ 25°C Ambient		> 60,000 hrs											

Metalumen's light level performance metrics are subject to manufacturers component tolerances.

WIRING

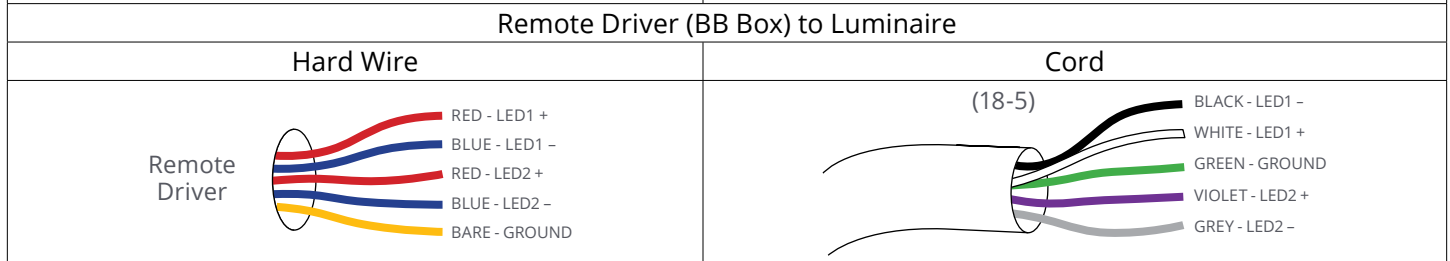
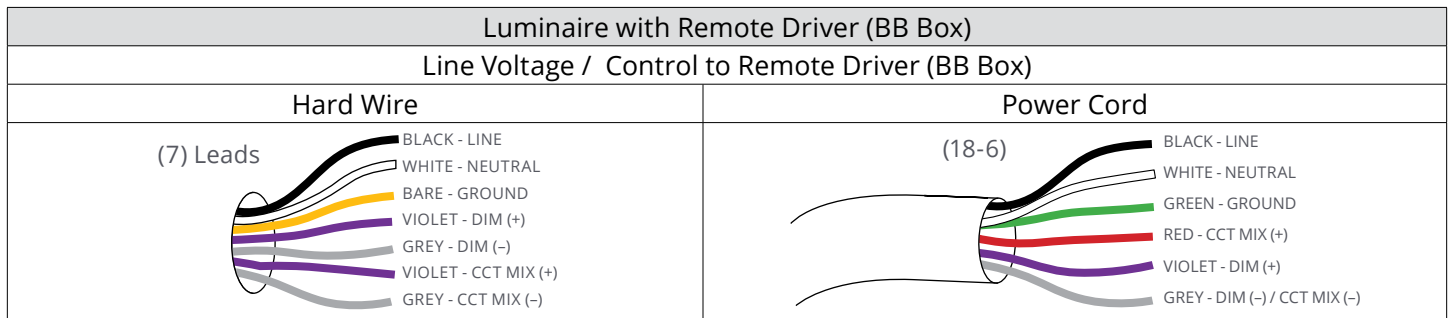
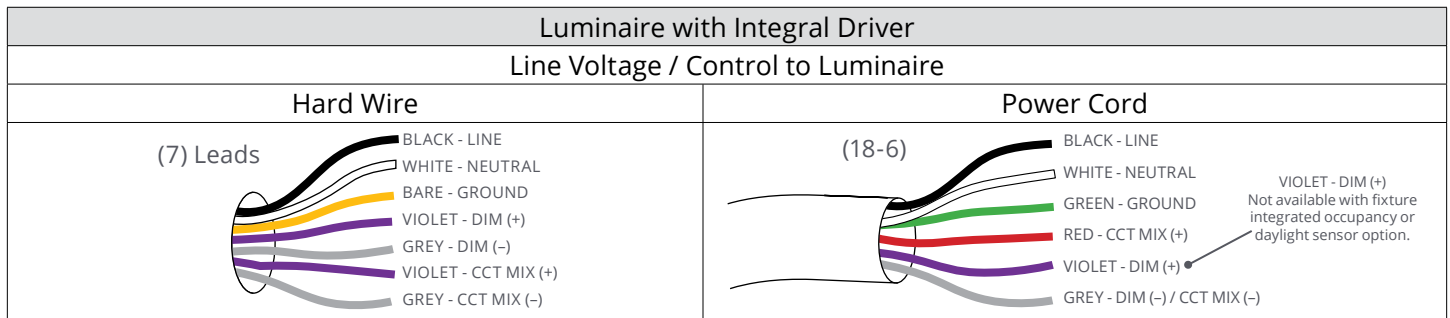
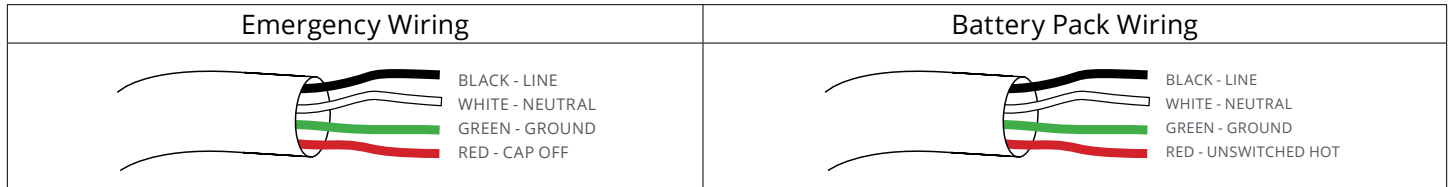

### CONTINUOUS ROWS



Step 1) Indicate desired quantity of rows under the QTY column

Step 2)  If applicable, select pod(s) per row to indicate desired Emergency lighting location. If a similar row requires a different Emergency lighting location, please fill out another sheet.

Record drawings for rows not represented here will be sent out upon order.

QTY	Nominal Length	Max. Recommended Length Drywall Opening (Max. Rec. Width = 105mm)	Alone / Start Length	Mid Length(s)	End Length	ROWS IN PLAN VIEW Rows are for demonstration purposes only and are not to scale.
4'	1235 [48.6]	4			1225 [48.2]	
8'	2452 [96.5]	8			2442 [96.1]	
12'	3671 [144.5]	12			3661 [144.1]	
16'	4891 [192.6]	8		8	4881 [192.2]	
20'	6110 [240.6]	12		8	6100 [240.2]	
24'	7329 [288.5]	12		12	7319 [288.1]	
28'	8548 [336.5]	8	12	8	8538 [336.1]	
32'	9767 [384.5]	12	8	12	9757 [384.1]	
36'	10987 [432.6]	12	12	12	10977 [432.2]	
40'	12206 [480.6]	12	8, 8	12	12196 [480.2]	
44'	13425 [528.5]	12	12, 8	12	13415 [528.1]	
48'	14644 [576.5]	12	12, 12	12	14634 [576.1]	

#### LEGEND

-  Standard (STD) Wire Entry Location (located on the end cap)
-  Emergency (EM) / Night Light Location (4 ft sections)
-  EM or Battery Wire Entry Location (EM wire entry is on the end cap)

---

**A**

 A = Run Length (Body)

---

EM / Night Light and EM or Battery Wire Entry location in relation to pod selections:

Example 20 ft run



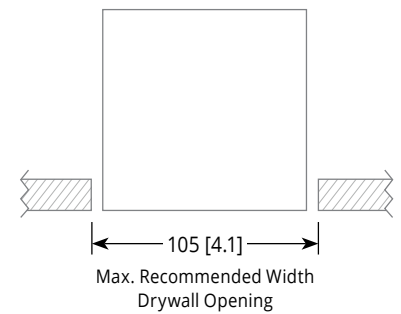

## CROSS SECTIONS

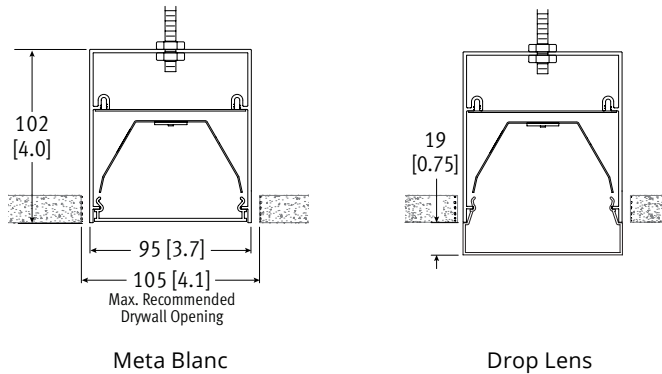

## SPECIFICATIONS

Due to the Continuous Improvement Policy at Metalumen, we reserve the right to change our specifications without notice.

**Housing:** Rigid extruded aluminum body, 2.0mm (0.08") nominal wall thickness. Aluminum end caps.

**Optical System:** Metalumen luminaires are designed to utilize leading edge LED technology combined with luminaire optimized reflectors and our custom diffusers, resulting in industry leading optical performance.

**CRI:** 80+ for all color temperature ranges.

**Lumen Maintenance:** Minimum 50,000h with TM-21 lumen maintenance of 85% @ 25°C ambient temperature (calculated based on IESNA LM-80-08 LED test data). L70: >60,000hrs.

**Finish:** Satin aluminum and white are standard finishes. For custom finish,

contact factory.

**Weight:** 1.3 kg/300 mm [2.9 lb/ft]

**Mounting:** Mounting brackets provided.

**Electrical:** Factory prewired with easy wire quick connect sections.

**Drivers:** Metalumen offers 0-10V dimming as a standard on our entire LED product offering. Dimming range is 1%-100%. Power factor is > 90%. Class

2 rating.

**Approvals:** Certified to NRTL and IES testing standards. This product is cULus listed. RoHS compliant. Plenum - CCEA approved.

**Environment:** Suitable for dry or damp locations.

## WARRANTY

Metalumen will warrant defective luminaires for 5 years from date of purchase. Warranty is valid if luminaire is installed and used according to specification. If defective, Metalumen will send replacement boards or drivers at no cost along with detailed replacement instructions and instructions on how to return defective components to Metalumen.