

# RAIL 1 RML

LED . PENDANT . DIRECT



PART #:	
PREP BY:	DATE:
PROJECT:	
NOTES:	
APPROVAL SIGNATURE:	DATE (DD/MM/YYYY):

PERFORMANCE SUMMARY at 3500K		Meta Cloud	Drop Lens
		L3	L3
Lumens per foot	80 CRI	527	559
	90 CRI	461	489
Wattage per foot		6.1	
Efficacy (lm/W)	80 CRI	87	93
	90 CRI	76	80
L70 Estimate (h)		≥ 60,000 hrs	

See page 2 for the complete Light Level Performance and 90 CRI Lumen Adjustment charts.

## FEATURES

- Narrow 1.2 inch profile
- 3/4 inch drop lens with seamless lines of light without pixels or shadows
- Suitable for dry or damp locations

## ORDERING LOGIC

Example Part Number: RML-1L35K-12-MC-W-L31-PA18-1-90

RML													
1	2	3	4	5	6	7	8	9	10	11	12	13	
1. SERIES	2. COLOR TEMP	3. LENGTH			4. PATTERN <sup>1</sup>				5. OPTICS UP	6. OPTICS DOWN	7. FINISH		
RML	1L30K 3000K 1L35K 3500K 1L40K 4000K	2 2 ft 3 3 ft 4 4 ft 5 5 ft 6 6 ft 7 7 ft 8 8 ft 9 9 ft 10 10 ft 11 11 ft 12 12 ft	GA Square GAxB Rectangle UAxBxC U-Shape LAxB L-Shape C Custom Pattern* _ None (leave space empty)				_ None (leave space empty)		MC Meta Cloud MD Drop Lens**	SA Satin Aluminum W White B Black C Custom Finish Specify RAL:			
90 CRI is available under OPTIONS		Standard Patterns Minimum Lengths Square: A=4 ft min. Rectangle: A=4 ft min, B=4 ft min. U-Shape: A=3 ft min, B=4 ft min, C=3 ft min. L-Shape: A=3 ft min, B=3 ft min.				Custom Patterns* Lengths and a drawing of custom pattern are required on page 3 T-Shape Cross/X		Select corner: <input type="checkbox"/> Outside 90° <input type="checkbox"/> Inside 90° 		Meta Cloud: Opal diffuse lens  Drop Lens: Opal diffuse lens			
8. LIGHT LEVEL / DRIVER		9. CIRCUITRY		10. MOUNTING			11. VOLTAGE		12. CONTROLS / SENSORS		13. OPTIONS		
L1 L2 L3 L4	Select Driver below. <b>(All drivers are remote.)</b>  See Light Level Performance chart on p2.	1 1 Circuit B Emergency Battery Pack <sup>2</sup>		PAA Pendant Aircraft Cable PTA Pendant Aircraft Cable for T-bar  Replace "A" with length (inches) selected below. Select Aircraft Cable Length and Canopy Finish below			1 120 V 2 277 V 3 347 V 4 UNV (120 - 277V)		_ None (leave space empty)		90 90 CRI, High R9 _ None (leave space empty)		

\*Consult factory. | \*\* Drop lens is not available with patterns. | <sup>1</sup> Pattern record drawings showing mounting locations and wire entries will be sent out upon order. | <sup>2</sup> Battery operates 4ft sections only.

### Select Aircraft Cable Length:

Total adjustment range is 6" up & down for each standard length. All other lengths are considered custom unless otherwise stated.

Select:	Imperial (in)	Metric (mm)
<input type="checkbox"/>	12	305
<input type="checkbox"/>	18	460
<input type="checkbox"/>	24	610
<input type="checkbox"/>	30	760
<input type="checkbox"/>	36	915
<input type="checkbox"/>	42	1067
<input type="checkbox"/>	48	1220

Select:	Imperial (in)	Metric (mm)
<input type="checkbox"/>	54	1372
<input type="checkbox"/>	60	1525
<input type="checkbox"/>	72	1830
<input type="checkbox"/>	96	2440
<input type="checkbox"/>	120	3050
<input type="checkbox"/>	144	3660
<input type="checkbox"/>	Custom Length: _____	

### Select Canopy Finish:

Select:	Canopy
<input type="checkbox"/>	White
<input type="checkbox"/>	Black
<input type="checkbox"/>	Custom Finish
	RAL: _____

### Select Driver:

- Factory option 0-10V, 1% Dimming
- LHE** Lutron H-Series Hi-lume 1% EcoSystem LED Driver
- LA2** Lutron A-Series Hi-lume 1% 2-wire LED Driver
- L5E** Lutron 5-Series EcoSystem LED Driver

Light Level Performance  
3500K, 80 CRI, 0-10V Dimming (Standard)

Optics	Meta Cloud			Drop Lens		
	Lumens per foot	Wattage per foot	Efficacy (lm/W)	Lumens per foot	Wattage per foot	Efficacy (lm/W)
L1	320	3.5	92	339	3.5	98
L2	395	4.4	89	419	4.4	95
L3	527	6.1	87	559	6.1	93
L4	971	12.1	80	1030	12.1	85

Lumen Adjustment Factor

Color Temp	80 CRI	90 CRI
3000K	0.984	0.880
3500K	1.000	0.875
4000K	1.032	0.879

Metalumen's light level performance metrics are subject to manufacturers component tolerances.

HANGER INFORMATION

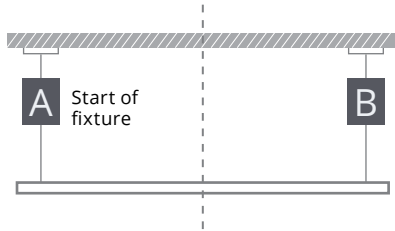

PENDANT AIRCRAFT CABLE

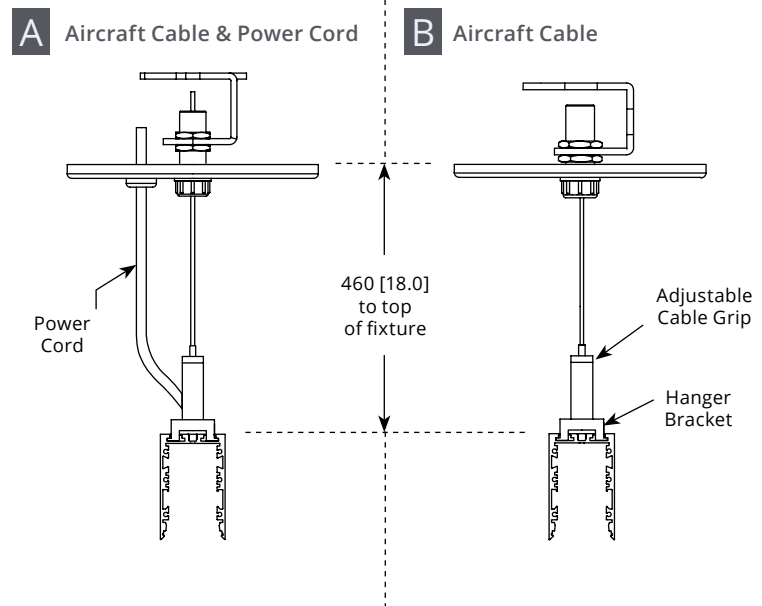

PENDANT AIRCRAFT CABLE FOR T-BAR

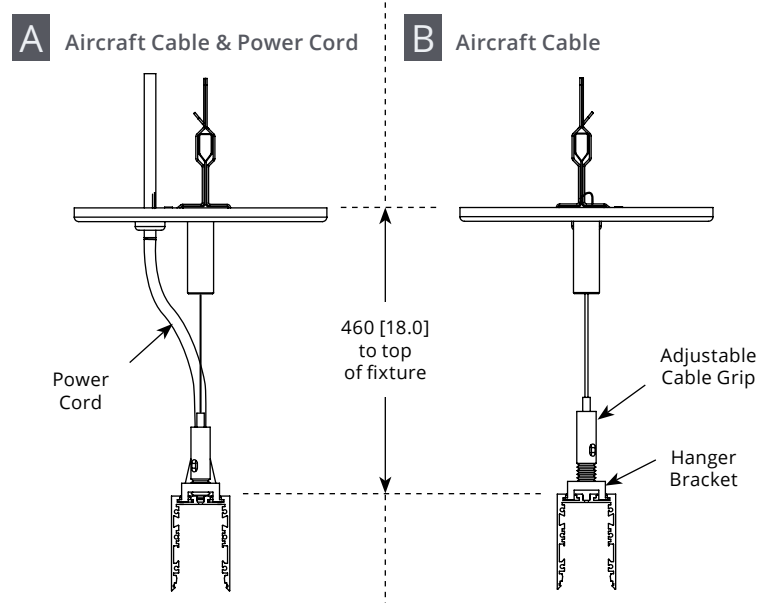

PATTERNS

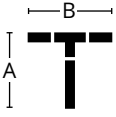
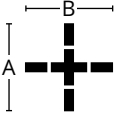
Select Pattern:	<input type="checkbox"/> T-SHAPE (C)	<input type="checkbox"/> CROSS / X-SHAPE (C)
Pattern Configuration		
Indicate Desired Lengths (ft)	A = B =	A = B =
Minimum Lengths	A = 3 ft B = 6 ft	A = 6 ft B = 6 ft

**A custom pattern configuration drawing is required in the grid below**

Approval drawings will be sent out upon order showing mounting locations.



## CROSS SECTIONS

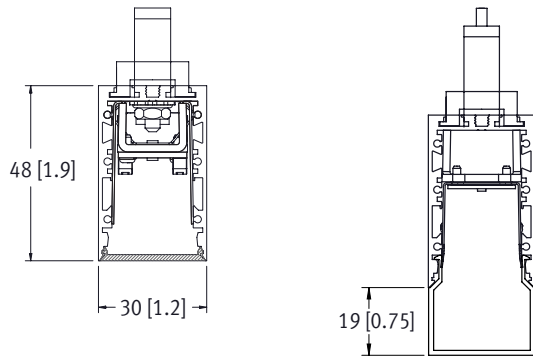

Meta Cloud

Drop Lens

## SPECIFICATIONS

Due to the Continuous Improvement Policy at Metalumen, we reserve the right to change our specifications without notice.

**Housing:** Anodized Extruded Aluminum 65% post-industrial recycled content complete with die cast zinc alloy powder coated end caps.

**Optical System:** Metalumen luminaires are designed to utilize leading edge LED technology combined with luminaire optimized reflectors and our custom diffusers, resulting in industry leading optical

performance.

**CRI:** 83 (3500K) (80 minimum)

**Lumen Maintenance:** Minimum 50,000h with TM-21 lumen maintenance of 85% @ 25°C ambient temperature (calculated based on IESNA LM-80-08 LED test data). L70: ≥60,000hrs.

**Finish:** Satin Aluminum, white and black are standard options. For custom finish, contact factory.

**Weight:** 1.0lb/ft or 0.5kg/300mm.

**Mounting:** Pendant Aircraft cable complete with a Quick-Grip field adjustable suspension system provides for quick and easy onsite alignment.

**Electrical:** Each section is individually connected in the field to a remote driver box.

**Drivers:** Metalumen offers dimming drivers as a standard on our entire LED

product offering at 0-10V. Dimming is 1%-100% range Power factor is >90% with a Class 2 rating. All drivers are remote mounted.

**Approvals:** Certified to NRTL and IES testing standards. All components are UL Recognized or Listed. RoHS compliant.

**Environment:** Suitable for dry or damp locations.

## WARRANTY

Metalumen will warrant defective luminaires for 5 years from date of purchase. Warranty is valid if luminaire is installed and used according to specification. If defective, Metalumen will send replacement boards or drivers at no cost along with detailed replacement instructions and instructions on how to return defective components to Metalumen.

PHOTOMETRIC DATA - 3500K, 80 CRI

Optics: **Meta Cloud**  
 IES File: **RML-1L35K-4-MC-L3**  
 Lumens: **527/ft** Wattage: **6/ft**  
 Efficacy: **87 lm/W**

**PHOTOMETRIC CURVE**  
 100% Down

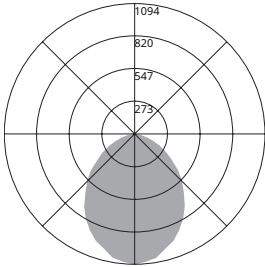

**ZONAL LUMEN SUMMARY**

Zone	Lumens	%Fixt
0-20	374	17.70
0-30	753	35.60
0-40	1160	54.90
0-60	1820	86.10
0-80	2094	99.10
0-90	2112	100.00
10-90	2012	95.20
20-40	786	37.20
20-50	1156	54.70
40-70	847	40.10
60-80	274	13.00
70-80	87	4.10
80-90	18	0.90
90-110	0	0.00
90-120	0	0.00
90-130	0	0.00
90-150	0	0.00
90-180	0	0.00
110-180	0	0.00
0-180	2112	100.00

**COEFFICIENTS OF UTILIZATION**

Zonal Cavity Method | Effective Floor Cavity Reflectance = .20

RC	80				70				50			
	RW	70	50	30	10	70	50	30	10	50	30	10
RCR												
0	119	119	119	119	116	116	116	116	111	111	111	111
1	110	106	102	99	108	104	100	97	100	97	94	94
2	101	94	88	83	99	92	87	82	89	84	80	80
3	93	84	76	71	91	82	75	70	79	74	69	69
4	86	75	67	61	84	74	66	61	71	65	60	60
5	80	68	60	54	78	67	59	53	65	58	53	53
6	74	62	53	47	72	61	53	47	59	52	47	47
7	69	56	48	42	67	56	48	42	54	47	42	42
8	65	52	44	38	63	51	44	38	50	43	38	38
9	60	48	40	35	59	47	40	35	46	39	35	35
10	57	44	37	32	56	44	37	32	43	36	32	32

**CANDELA DISTRIBUTION**

Vertical Angle	Horizontal Angle				
	0	22.5	45	67.5	90
0	1094	1094	1094	1094	1094
5	1074	1073	1053	1049	1074
10	1053	1051	1031	1016	1012
15	992	992	985	956	937
20	951	930	894	868	871
25	887	860	823	782	764
30	815	785	740	693	673
35	736	700	646	595	584
40	641	620	553	506	497
45	560	530	470	430	415
50	477	445	390	353	336
55	381	362	318	283	272
60	307	283	248	219	210
65	232	214	184	158	148
70	163	151	128	108	104
75	105	95	78	65	62
80	55	49	37	32	29
85	20	17	11	9	9
90	4	2	1	1	1

**LUMINANCE DATA (CD/M<sup>2</sup>)**

Vertical Angle	Horizontal Angle		
	0	45	90
45	20944	8413	6170
55	17284	5707	3942
65	13923	3400	2161
75	9716	1538	930
85	4415	251	142

Optics: **Drop Lens**  
 IES File: **RML-1L35K-4-MD-L3**  
 Lumens: **559/ft** Wattage: **6/ft**  
 Efficacy: **93 lm/W**

**PHOTOMETRIC CURVE**  
 100% Down

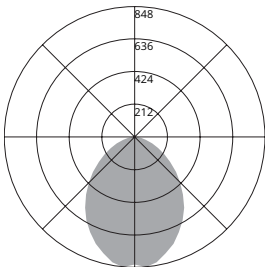

**ZONAL LUMEN SUMMARY**

Zone	Lumens	%Fixt
0-20	293	13.10
0-30	593	26.50
0-40	929	41.50
0-60	1545	69.00
0-80	1917	85.60
0-90	2009	89.70
10-90	1930	86.20
20-40	636	28.40
20-50	965	43.10
40-70	839	37.50
60-80	372	16.60
70-80	150	6.70
80-90	91	4.10
90-110	116	5.20
90-120	157	7.00
90-130	189	8.40
90-150	223	10.00
90-180	230	10.30
110-180	115	5.10
0-180	2239	100.00

**COEFFICIENTS OF UTILIZATION**

Zonal Cavity Method | Effective Floor Cavity Reflectance = .20

RC	80				70				50			
	RW	70	50	30	10	70	50	30	10	50	30	10
RCR												
0	117	117	117	117	113	113	113	113	105	105	105	105
1	106	101	96	92	102	97	93	90	91	88	85	85
2	96	88	81	75	93	85	79	73	80	75	70	70
3	88	77	69	63	84	75	67	61	70	64	59	59
4	81	69	60	53	77	67	59	52	63	56	51	51
5	74	62	53	46	71	60	52	45	57	49	44	44
6	69	56	47	41	66	54	46	40	51	44	39	39
7	64	51	42	36	61	49	41	35	47	40	35	35
8	59	46	38	32	57	45	37	32	43	36	31	31
9	56	43	34	29	54	42	34	29	40	33	28	28
10	52	39	32	26	50	38	31	26	37	30	26	26

**CANDELA DISTRIBUTION**

Vertical Angle	Horizontal Angle				
	0	22.5	45	67.5	90
0	827	827	827	827	827
5	848	844	838	838	818
10	826	811	811	801	787
15	782	777	758	744	729
20	739	730	708	692	684
25	682	673	647	634	623
30	624	616	594	575	565
35	561	548	529	524	522
40	489	482	473	475	481
45	418	418	420	436	437
50	353	360	373	386	393
55	281	299	328	344	346
60	225	247	276	296	304
65	170	198	229	250	257
70	123	152	189	211	218
75	76	111	149	172	174
80	45	77	120	138	144
85	20	52	94	111	115
90	8	39	77	93	100

**LUMINANCE DATA (CD/M<sup>2</sup>)**

Vertical Angle	Horizontal Angle		
	0	45	90
45	15161	6094	5128
55	12296	4645	3866
65	9702	3250	2823
75	6615	2194	1933
85	3866	1481	1333

Photometric performance is measured and scaled in accordance with IESNA LM-79.