

RAIL 6 S6

LED . RECESSED DRYWALL FLANGELESS . DIRECT

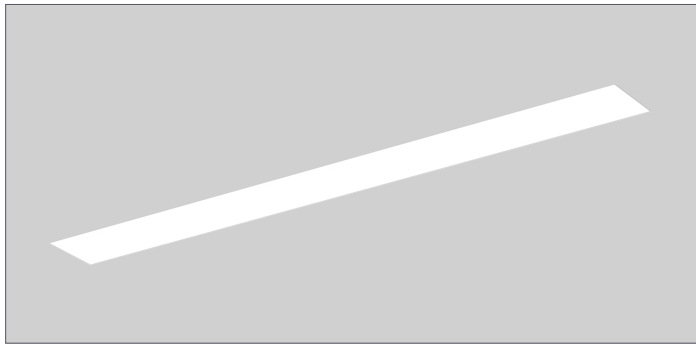

PART #:	
PREP BY:	DATE:
PROJECT:	QTY:
NOTES:	
APPROVAL SIGNATURE:	DATE (DD/MM/YYYY):

PERFORMANCE SUMMARY @ 3500K

		Meta Blanc (MB)	Meta Ice (M)	Drop Lens (MD)
		L3	L3	L3
Lumens per foot	80 CRI	609	713	642
	90 CRI	533	624	562
Wattage per foot		6.1	6.1	6.1
Efficacy	80 CRI	101	118	106
	90 CRI	87	102	92
L70 Estimate (h)		≥ 60,000 hrs		

See page 2 for the complete Light Level Performance chart.

FEATURES

- Efficacy up to 111 LPW
- Suitable for dry or damp locations
- Integral drivers
- Option for daylight harvesting, occupancy sensing, dimming control and emergency lighting

ORDERING LOGIC

Example Part Number: S6-1L35K-12-MB-W-L31-DF-1-DW-90

S6													DF	
1	2	3	4	5	6	7	8	9	10	11	12	13		
1. SERIES S6	2. COLOR TEMP 1L30K 3000K 1L35K 3500K 1L40K 4000K 90 CRI is available under OPTIONS	3. LENGTH 2 2 ft 3 3 ft 4 4 ft 5 5 ft 6 6 ft 7 7 ft 8 8 ft 9 9 ft 10 10 ft 11 11 ft 12 12 ft RA Continuous Rows Replace "A" with length in feet selected on p2 C Custom Length* - None (leave space empty)	4. PATTERN ¹ GA Square GAxB Rectangle UAxBxC U-Shape LAxB L-Shape C Custom Pattern* - None (leave space empty) Standard Patterns Minimum Lengths A = 4 ft min, B = 4 ft min. A = 3 ft min, B = 4 ft min, C = 3 ft min. A = 3 ft min, B = 3 ft min. Custom Patterns* Lengths and a drawing of custom pattern are required on page 3 T-Shape Cross/X Select corner: <input type="checkbox"/> Outside 90° <input type="checkbox"/> Inside 90° 					5. OPTICS MB Meta Blanc M Meta Ice MD Drop Lens ** Meta Blanc & Drop Lens: Opal diffuse lens Meta Ice: High output semi-diffuse lens	6. FINISH SA Satin Aluminum W White B Black C Custom Finish Specify RAL:					
7. LIGHT LEVEL / DRIVER L1 L2 Select Driver below. L3 See Light Level Performance chart on p2. L4 LX Enter desired lm/ft:	8. CIRCUITRY 1 1 Circuit EM Emergency / Night Light B Emergency Battery Pack ²	9. MOUNTING DF Recessed Drywall Flangeless	10. VOLTAGE 1 120 V 2 277 V 3 347 V 4 UNV (120 - 277V)	11. SENSORS	12. CONTROLS Please see last page for fixture integrated SENSORS and CONTROLS Order Logic codes	13. OPTIONS 90 90 CRI, High R9 - None (leave space empty)								

*Consult factory. | **Drop lens is not available with patterns. | ¹ Pattern record drawings showing mounting locations will be sent out upon order. | ² Battery operates 4ft sections only.

Select Driver:

- Factory option 0-10V, 1% Dimming
- LHE** Lutron H-Series Hi-lume 1% EcoSystem LED Driver
- LA2** Lutron A-Series Hi-lume 1% 2-wire LED Driver
- LSE** Lutron 5-Series EcoSystem LED Driver

Light Level Performance

3500K, 80 CRI, 0-10V Dimming

Optics	Meta Blanc (MB)			Meta Ice (M)			Drop Lens (MD)		
	Lumens per foot	Wattage per foot	Efficacy (LPW)	Lumens per foot	Wattage per foot	Efficacy (LPW)	Lumens per foot	Wattage per foot	Efficacy (LPW)
L1	370	3.5	107	433	3.5	125	377	3.5	108
L2	456	4.4	104	533	4.4	121	472	4.4	107
L3	609	6.1	101	713	6.1	118	642	6.0	106
L4	1121	12.5	90	1312	12.5	105	1191	12.5	95.4

Lumen Adjustment Factor

Color Temp	80 CRI	90 CRI
3000K	0.984	0.880
3500K	1.000	0.875
4000K	1.032	0.879

Metalumen's light level performance metrics are subject to manufacturers component tolerances.

CONTINUOUS ROWS

Step 1) Indicate desired quantity of rows under the QTY column

Step 2) ← Pods → If applicable, select pod(s) per row to indicate desired Emergency Lighting/Night Light/Battery Location. If a similar row requires a different Emergency lighting location, please fill out another sheet.

Record drawings for rows not represented here will be sent out upon order.

LEGEND

- Standard (STD) Wire Entry Location (located 52mm from end on top of fixture)
- Emergency (EM) / Night Light Location (4 ft sections)
- EM or Battery Wire Entry Location (located 52mm from end on top of fixture)

EM / Night Light and EM or Battery Wire Entry location in relation to pod selections:

Example 20 ft run

QTY	Nominal Length	Run Length Overall	Alone / Start Length	Mid Length(s)	End Length	ROWS IN PLAN VIEW					
						Rows are for demonstration purposes only and are not to scale.					
4'	1223 [48.1]	4									
8'	2442 [96.1]	8									
12'	3662 [144.2]	12									
16'	4880 [192.1]	8		8							
20'	6100 [240.2]	12		8							
24'	7320 [288.2]	12		12							
28'	8538 [336.1]	8	12	8							
32'	9758 [384.2]	12	8	12							
36'	10978 [432.2]	12	12	12							
40'	12196 [480.2]	12	8, 8	12							
44'	13416 [528.2]	12	12, 8	12							
48'	14636 [576.2]	12	12, 12	12							

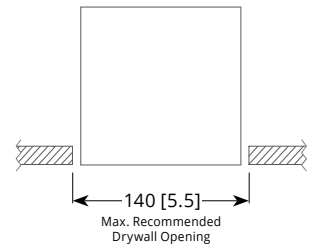

PATTERNS

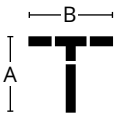
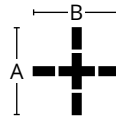

Select Pattern:	<input type="checkbox"/> T-SHAPE (C)	<input type="checkbox"/> CROSS / X-SHAPE (C)
Pattern Configuration		
Indicate Desired Lengths (ft)	A = B =	A = B =
Minimum Lengths	A = 3 ft B = 6 ft	A = 6 ft B = 6 ft

A custom pattern configuration drawing is required in the grid below

Approval drawings will be sent out upon order showing mounting locations.



WIRING

Standard	Emergency / Night Light	Emergency Battery Pack
 <p>BLACK - LINE WHITE - NEUTRAL GREEN - GROUND RED - CAPPED/SW LEAD VIOLET - DIM(+) PINK - DIM(-)</p>	 <p>BLACK - LINE WHITE - NEUTRAL GREEN - GROUND RED - CAP OFF</p>	 <p>BLACK - LINE WHITE - NEUTRAL GREEN - GROUND RED - UNSWITCHED HOT</p>

CROSS SECTIONS

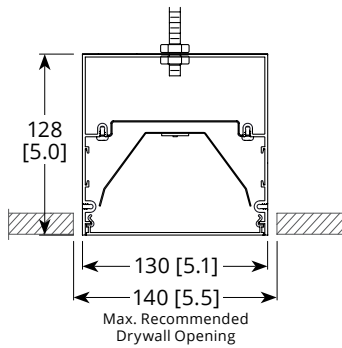

Meta Blanc or Meta Ice

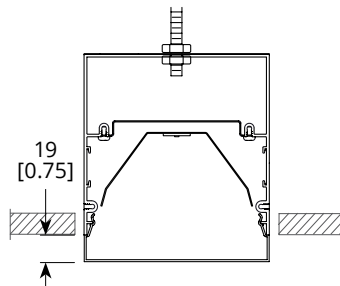

Drop Lens

SPECIFICATIONS

Due to the Continuous Improvement Policy at Metalumen, we reserve the right to change our specifications without notice.

Housing: Rigid extruded aluminum body, 2.0mm (0.08”) nominal wall thickness. Aluminum end caps.
Optical System: Metalumen luminaires are designed to utilize leading edge LED technology combined with luminaire optimized reflectors and our custom diffusers, resulting in industry leading optical performance.
CRI: 83+ for 3500K, 80 minimum for all

CCTs in standard configurations.
Lumen Maintenance: Minimum 50,000h with TM-21 lumen maintenance of 85% @ 25°C ambient temperature (calculated based on IESNA LM-80-08 LED test data). L70: ≥60,000hrs.
Finish: Satin aluminum and white are standard finishes. For custom finish, contact factory.
Weight: 1.7 kg/300 mm [3.8 lb/ft]

Mounting: Mounting rods provided by others.
Electrical: Factory prewired with easy wire quick connect sections.
Drivers: Metalumen offers 0-10V dimming* as a standard on our entire LED product offering. Dimming range is 1%-100%. Power factor is > 90%. Class 2 rating. Drivers are integral.
Approvals: All components are UL/

CSA/QPS recognized or listed. RoHS compliant. This product is cULus listed.
Environment: Suitable for dry or damp locations.
**Standard drivers compatible with passive/sinking dimmers. Please contact Metalumen if active/sourcing dimmer support is required.*

WARRANTY

Metalumen will warrant defective luminaires for 5 years from date of purchase. Warranty is valid if luminaire is installed and used according to specification. If defective, Metalumen will send replacement boards or drivers at no cost along with detailed replacement instructions and instructions on how to return defective components to Metalumen.

PHOTOMETRIC DATA - 3500K, 80 CRI

Optics: **Meta Blanc**
 IES File: **S6-1L35K-4-MB-L3**
 Lumens: **609/ft** Wattage: **6.1/ft**
 Efficacy: **101 LPW**

ZONAL LUMEN SUMMARY

Zone	Lumens	%Fixt
0-90	2435	100
90-180	0	0
0-180	2435	100

LUMINANCE DATA (CD/M2)

Vertical Angle	Horizontal Angle		
	0	45	90
45	4443	2684	2224
55	3665	1899	1520
65	2843	1223	937
75	1889	623	454
85	733	153	113

PHOTOMETRIC CURVE

100% Down

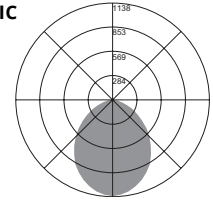

Optics: **Meta Ice**
 IES File: **S6-1L35K-4-M-L3**
 Lumens: **713/ft** Wattage: **6.1/ft**
 Efficacy: **118 LPW**

ZONAL LUMEN SUMMARY

Zone	Lumens	%Fixt
0-90	2855	100
90-180	0	0
0-180	2855	100

LUMINANCE DATA (CD/M2)

Vertical Angle	Horizontal Angle		
	0	45	90
45	5198	3134	2581
55	4347	2212	1751
65	3365	1427	1090
75	2172	730	518
85	839	175	137

PHOTOMETRIC CURVE

100% Down

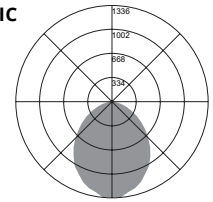

Optics: **Drop Lens**
 IES File: **S6-1L35K-4-MD-L3**
 Lumens: **642/ft** Wattage: **6.0/ft**
 Efficacy: **106 LPW**

ZONAL LUMEN SUMMARY

Zone	Lumens	%Fixt
0-90	2440	94.9
90-180	131	5.1
0-180	2571	100

LUMINANCE DATA (CD/M2)

Vertical Angle	Horizontal Angle		
	0	45	90
45	5198	3134	2581
55	4347	2212	1751
65	3365	1427	1090
75	2172	730	518
85	839	175	137

PHOTOMETRIC CURVE

5% Up
95% Down

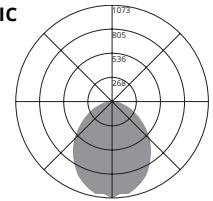

Photometric performance is measured and scaled in accordance with IESNA LM-79.

SENSORS AND CONTROLS



Metalumen offers intelligent standalone and/or connected luminaires with various integrated sensing and control system* connectivity options. The table below outlines some of the more common combinations and solutions offered. If you do not see the controls solution or the type of sensing technology you require for your project please contact us and we will work with you to try and identify a solution to meet your needs.

*Control system, installation and commissioning provided by others.

Examples:

WattStopper Daylight Sensor Standalone Luminaire: S6-1L35K-12-MB-W-L31-DF-1-DW-90

Occupancy Sensor with Casambi Wireless Bluetooth Mesh Control Capability: S6-1L35K-12-MB-W-L31-DF-1-O-CAB-90

ORDER LOGIC FIELDS		SENSOR FEATURE / BEHAVIOR		LUMINAIRE CONTROL / CONNECTIVITY	DESCRIPTION
11. SENSORS	12. CONTROLS	OCCUPANCY (PIR)	DAYLIGHT HARVESTING		
OF	-		None	Standalone	Factory Sensor - Occupancy Behaviors configured via BLE App
OW	-		None	Standalone (WattStopper)	Wattstopper Standalone Occupancy Sensor
DW	-	None		Standalone (WattStopper)	Wattstopper Standalone Daylight Harvesting Sensor
ODW	-			Standalone (WattStopper)	Wattstopper Standalone Occupancy and Daylight Harvesting Sensors
O	- CAB		None	Casambi Bluetooth Mesh	Casambi Bluetooth Mesh Connectivity with Occupancy Sensing
OD	- CAB			Casambi Bluetooth Mesh	Casambi Bluetooth Mesh Connectivity with Daylight Harvesting and Occupancy Sensing
	- CAB	None	None	Casambi Bluetooth Mesh	Casambi Bluetooth Mesh Connectivity (no sensors)
O	- SLVR		None	Silvair Bluetooth Mesh	Open Standard Bluetooth Mesh Connectivity with Occupancy Sensing
OD	- SLVR			Silvair Bluetooth Mesh	Open Standard Bluetooth Mesh Connectivity with Daylight Harvesting and Occupancy Sensing
	- SLVR	None	None	Silvair Bluetooth Mesh	Open Standard Bluetooth Mesh Connectivity (no sensors)
	- OSRM	None	None	Osram Enceium	Osram Enceium connectivity
OD	- OSRM			Osram Enceium	Osram SensiLum Connectivity for Enceium with Occupancy and Daylight Harvesting
OD	- ENL			Enlighted ONE	Occupancy and Daylight Harvesting Capable Supports EnlightedONE room control as well and upgrade path for Enlighted Connected and Enlighted IoT offering advanced applications, analytics and insights for Space Utilization/Optimization, Asset Tracking, Energy Monitoring, HVAC Integration etc..
	- DALI	None	None	DALI addressable wired Luminaire	Generic DALI addressable luminaire
	- ECOS	None	None	Lutron Ecosystem	Lutron Ecosystem addressable wired luminaire NOTE: See Driver Selection options for specific driver

