

NOTE: The following instructions provide general guidelines for product installation. For additional information consult the applicable electrical codes or contact factory directly for support before attempting anything with uncertainty.

WARNING: Risk of fire and electrical shock. **DISCONNECT POWER AT ELECTRICAL PANEL** before installing or servicing this product.

GENERAL SAFETY INSTRUCTIONS:

1. Read all instructions prior to installing this fixture.
2. This product must be installed in accordance with the applicable installation code by a person familiar with the construction and operation of the product and the hazards involved.
3. All wiring must be performed by a qualified electrician in accordance with national and local building and electrical codes.
4. This fixture must be suitably grounded for your protection against shock hazards and to assure proper operation.
5. Make sure that the power source conforms to the requirements of this fixture.
6. This product has accessible output terminals. Based on Canadian Electrical Code for class 2 circuits, this product requires installation in Restricted Access Area, so that no live parts are accessible to unauthorized persons.

Specifications and design subject to change without notice.

PARTS LIST: 1x4 INTEGRAL DRIVER

PARTS LIST

- A. Hanger Bracket Base
- B. Luminaire

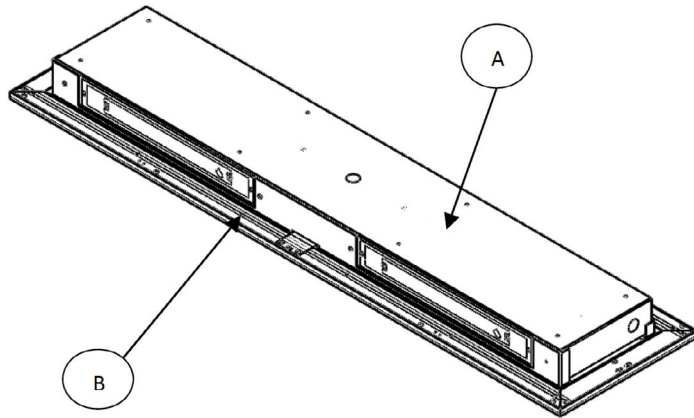

WIRING DIAGRAMS

FIXTURE TO REMOTE / INTEGRAL DRIVER

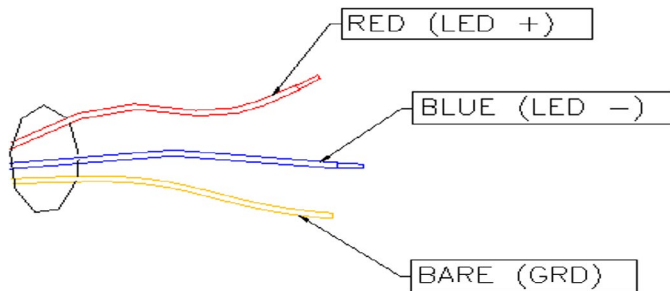

REMOTE / INTEGRAL DRIVER TO LINE VOLTAGE.

WIRE ENTRY 5 LEADS



Specifications and design subject to change without notice.

STEP-BY-STEP INSTALLATION INSTRUCTIONS

Applicable for both 1x4 and 2x2

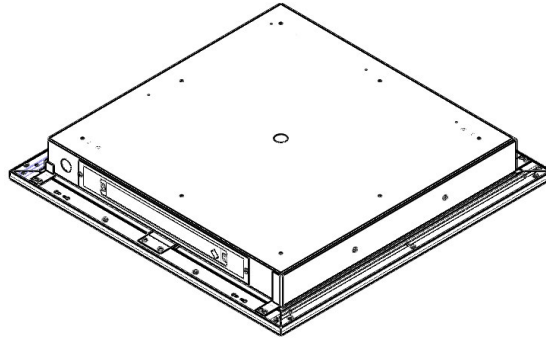

STEP 1. Remove fixture and all supplied parts from packaging. **DO NOT REMOVE** the protective film from the front surface of the fixture.

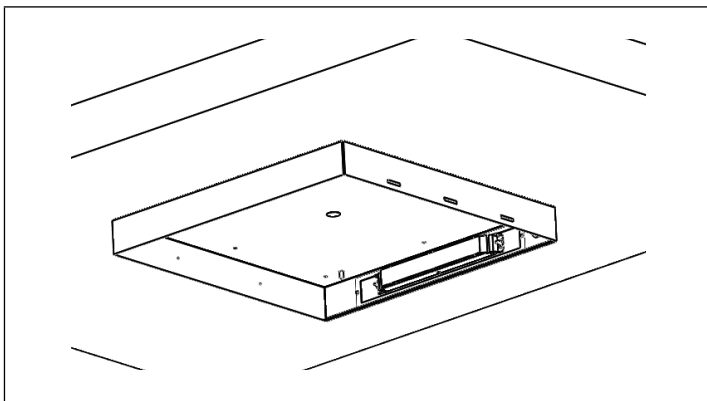

STEP 2. Install hanger bracket base (A) into ceiling.

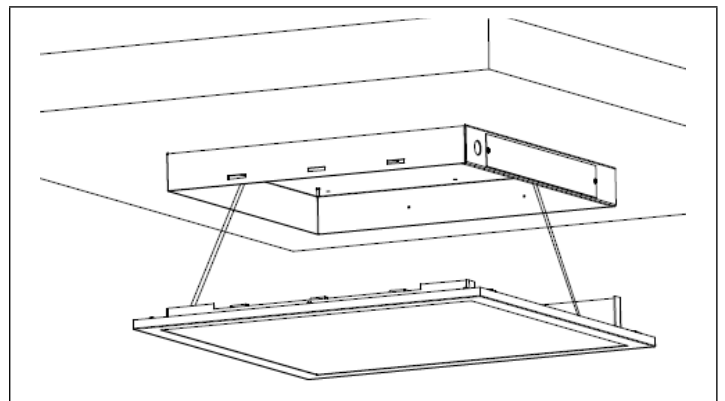

STEP 3. Attach safety cable from fixture to hanger bracket

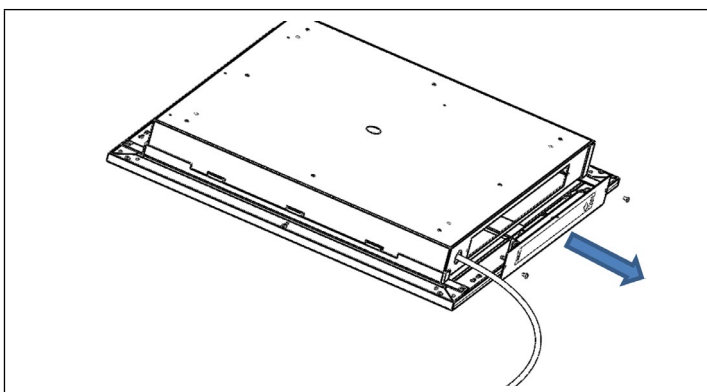

STEP 4. Unscrew and remove driver access panel to expose the driver. Insert line voltage through cut out and wire integral driver to line voltage. (Refer to wiring diagram from pg.2). Re-attach access panel to hanger bracket base.

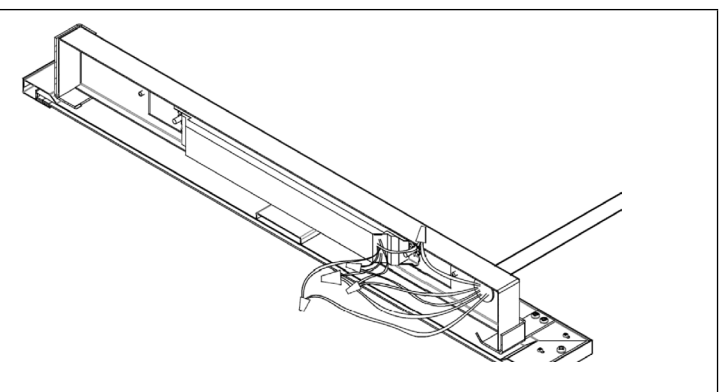

Specifications and design subject to change without notice.

STEP-BY-STEP INSTALLATION INSTRUCTIONS

Applicable for both 1x4 and 2x2

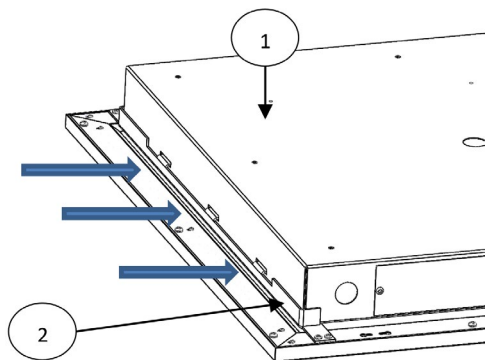

STEP 5. Secure the fixture to the **hanger bracket base [1]** by first inserting the tabs on the left side of the **hanger bracket [2]** into the slots of the **hanger bracket base [1]**.

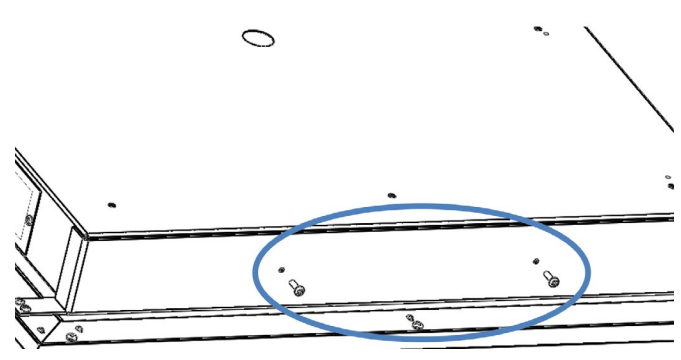

STEP 6. Secure luminaire to hanger bracket base using the #8 1/2" screws.

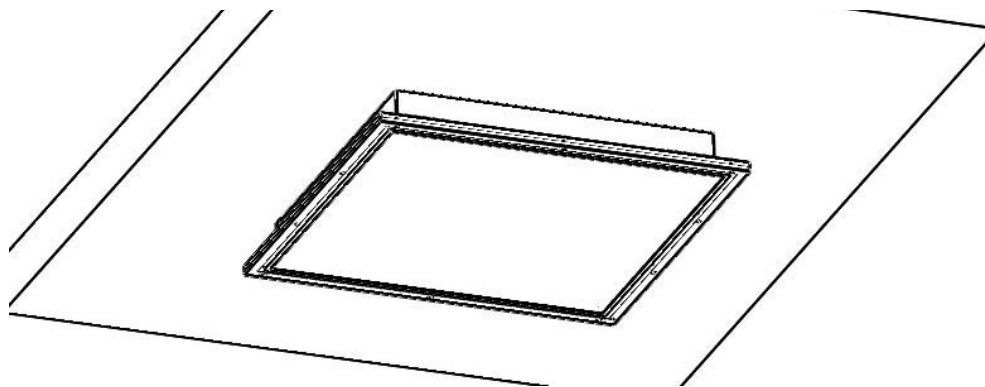

STEP 7. Remove protective film from the front surface of the light fixture when installation is completed.

Specifications and design subject to change without notice.

MAINTENANCE STEPS

Required Tools

Plastic / Latex
Gloves



Screwdriver



Important: Use clean gloves to avoid adding oil/dirt to reflector surface. Avoid scratching reflector surface by using installation tools with soft plastic rounded edges.

To Clean the Optics:

Gently wipe down the optics with a clean, dry cloth to remove any dust and light residues. For heavier smudges, spray clean cloth with mild soap and water solution and gently wipe optics surface.

WARNING: Hard wiping and abrasive cloths will scratch the optics. DO NOT USE cleaning products containing alcohol or acetone which will damage the optics.

Specifications and design subject to change without notice.