

SCENE SCÉM

MEDICAL . LED . SURFACE . DIRECT

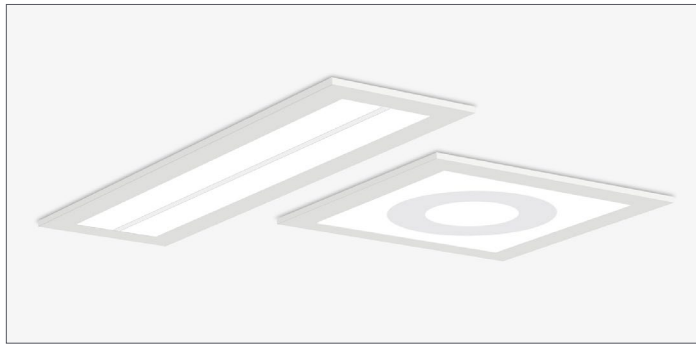

- Specification Grade Edgelit Light Guide Luminaire
- Efficacy up to 97 LPW
- Suitable for dry or damp locations
- Remote driver



PART #:		DATE:	
PREP BY:		QTY:	
PROJECT:		NOTES:	
APPROVAL SIGNATURE:		DATE (DD/MM/YYYY):	

PERFORMANCE SUMMARY @ 3500K		2X2			1X4	
		PQ	QQ / CC	SD	PS	SD
Light Level		L1				
Lumens	80 CRI	2053	2042	2227	1905	2037
Wattage		24	24	24	21	21
Efficacy	80 CRI	86	85	93	91	97
L70 Estimate (h)		≥ 60,000 hrs				

See page 2 for the complete Light Level Performance chart.

OTHER SCENE PRODUCTS

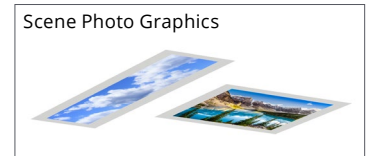

ORDERING LOGIC

Example Part Number: SCÉM-2L35K-22-QQ-AM-L31-S-1-NRF

SCÉM	1	2	3	4	AM	6	7	S	9	N	11
1. SERIES SCÉM	2. COLOR TEMP		3. CONFIGURATIONS		4. OPTICS		5. FINISH		6. LIGHT LEVEL / DRIVER		
	2L30K 3000K	2L35K 3500K	22 2x2 ft	14 1x4 ft	PQ Perforated Square	QQ Square in Square	CC Circle in Circle	SD Standard Diffuser	2x2' Optics Lumen Codes		
2L40K 4000K	2L50K 5000K	2x2' Configurations		1x4'		PS Perforated Strip		SD Standard Diffuser		1x4' Optics Lumen Codes	
		B E H	C F I	D G	CUSTOM GRAPHIC		Must be ordered through the SCENE PHOTO GRAPHICS Spec Sheet		*Please note Light Level Codes have been updated in accordance with UL certification standards.		
90 CRI is available under OPTIONS		See next page for configuration diagrams						Refer to the Light Level Performance chart on the next page for additional information.			Select Driver below.
		M Custom configuration									
7. CIRCUITRY			8. MOUNTING		9. VOLTAGE		10. CONTROLS / SENSORS		11. OPTIONS		
1 1 Circuit			S Surface		1 120V		N None		N None		
EM Emergency / Night Light					2 277V				RF Medical Power Line Filter (Remote)		
B Emergency Battery Pack					3 347V						
					4 UNV(120 - 277V)						

- Select Driver:
- Factory option 0-10V, 1% Dimming
 - D2** DALI
 - LHE** Lutron H-Series Hi-lume 1% EcoSystem LED Driver
 - LSE** Lutron 5-Series EcoSystem LED Driver

Light Level Performance | 3500K, 80 CRI, 0-10V Dimming (Standard)

2x2											1x4						Lumen Adjustment Factor					
Optics	Perforated Square (PQ)			Square in Square (QQ)			Circle in Circle (CC)			Standard Diffuse (SD)			Optics	Perforated Strip (PS)			Standard Diffuse (SD)			Color Temp	80 CRI	90 CRI
Light Level	Lumens	Wattage	Efficacy (LPW)	Lumens	Wattage	Efficacy (LPW)	Lumens	Wattage	Efficacy (LPW)	Lumens	Wattage	Efficacy (LPW)	Light Level	Lumens	Wattage	Efficacy (LPW)	Lumens	Wattage	Efficacy (LPW)			
L1	2053	24	86	2042	24	85	2042	24	85	2227	24	93	L1	1905	21	91	2037	21	97	3000K	0.984	0.880
L2	2947	37	80	2816	37	76	2816	37	76	3185	37	86	L2	3727	48	78	4068	48	85	3500K	1.000	0.875
L3	3316	43	77	3251	43	76	3251	43	76	3581	43	83	L3	5668	74	77	5814	74	79	4000K	1.032	0.879
L4	3794	51	74	3852	51	76	3846	51	75	4090	51	80	L4	6469	85	76	6522	85	77	5000K	1.032	0.879

Metalumen's light level performance metrics are subject to manufacturers component tolerances.

CONFIGURATIONS

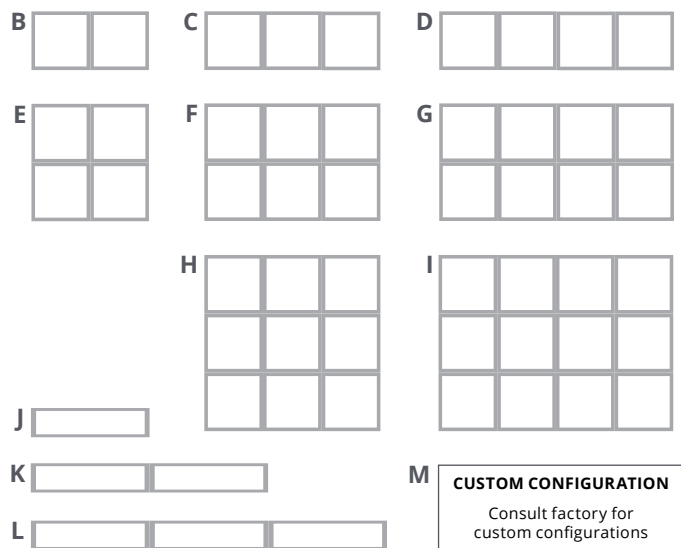

STANDARD OPTICS

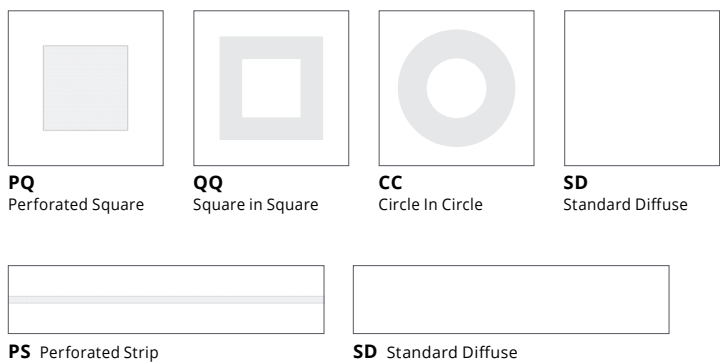

To clean the optics:
Gently wipe down the optics with a clean, dry cloth to remove any dust and light residues. For heavier smudges, spray clean cloth with mild soap and water solution and gently wipe optics surface.
Warning: Hard wiping and abrasive cloths will scratch the optics.
Do not use cleaning products containing alcohol or acetone which will damage the optics.

SPECIFICATIONS

Due to the Continuous Improvement Policy at Metalumen, we reserve the right to change our specifications without notice.

Housing: Luminaire body is constructed with 22 gauge cold rolled steel and 20 gauge aluminum, and welded seams.
Optical System: The light emitted from the mid-flux LEDs is channeled inside Metalumen's AccuRay® optical plane where a precisely controlled micro dot matrix pattern directs, shapes and distributes the light throughout the material. A high performance optical reflector and diffuser further guide and extract the light with superb efficiency and beam control. Standard optics available. Custom graphics must be ordered

through the SCENE PHOTO GRAPHICS Spec Sheet.
CRI: 83+ (3500K) (80 minimum) Consult factory for 90+ CRI.
Lumen Maintenance: At an ambient operating temperature of 25°C the LED lifetime expectancy ≥ 60 000hrs at L70.
Finish: The luminaire housing and associated parts are finished in highly reflective, matte powder coat white paint (91% reflectance) or antimicrobial white paint. For custom finish, consult factory.
Mounting: Surface mounting brackets provided.
Drivers: Metalumen offers dimming*

drivers as a standard on our entire LED product offering at 0-10V. Dimming range is 1%-100%. Power factor is > 90%. Class 2 rating. One driver box per luminaire is provided. Driver is remote.
RFI Filter: The noise suppression filter provides exceptional suppression of broadband, common mode, and differential mode noise across a wide frequency range, ensuring stable, interference-free power converter operation. Effective above 30kHz, it adapts dynamically to operational conditions, reducing harmonics and mitigating high-frequency parasitics for optimal performance. When

installed, the RFI filter is placed inside a remote driver box.
Approvals: Certified to NRTL safety and IES Recommended testing standards. All components are UL/CSA/QPS recognized or listed, RoHS, LM79, LM80 and LM82 compliant. This product is cULus listed and retains the listing with the remote battery pack.
Environment: Suitable for dry or damp locations.
**Standard drivers compatible with passive/sinking dimmers. Please contact Metalumen if active/sourcing dimmer support is required.*

WARRANTY

Metalumen will warrant defective luminaires for 5 years from date of purchase. Warranty is valid if luminaire is installed and used according to specification. If defective, Metalumen will send replacement boards or drivers at no cost along with detailed replacement instructions and instructions on how to return defective components to Metalumen.

PHOTOMETRIC DATA - 3500K, 80 CRI

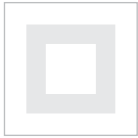

Optics: **Square in Square**
 IES File: **SCE-2L35K-22-QQ-L3**
 Lumens: **3251** Wattage: **43**
 Efficacy: **76 LPW**

ZONAL LUMEN SUMMARY

Zone	Lumens	%Fixt
0-90	3251	100
90-180	0	0
0-180	3251	100

LUMINANCE DATA (CD/M2)

Vertical Angle	Horizontal Angle		
	0	45	90
45	3736	3736	3736
55	3571	3571	3571
65	3294	3294	3294
75	2750	2750	2750
85	1553	1553	1553

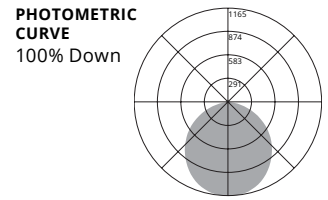

Optics: **Circle in Circle**
 IES File: **SCE-2L35K-22-CC-L3**
 Lumens: **3251** Wattage: **43**
 Efficacy: **76 LPW**

ZONAL LUMEN SUMMARY

Zone	Lumens	%Fixt
0-90	3316	100
90-180	0	0
0-180	3316	100

LUMINANCE DATA (CD/M2)

Vertical Angle	Horizontal Angle		
	0	45	90
45	3834	3834	3834
55	3674	3674	3674
65	3376	3376	3376
75	2736	2736	2736
85	1195	1195	1195

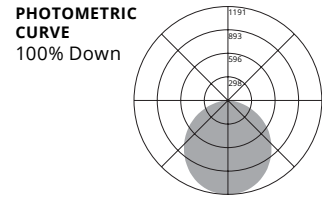

Optics: **Perforated Square**
 IES File: **SCE-2L35K-22-PQ-L3**
 Lumens: **3316** Wattage: **43**
 Efficacy: **77 LPW**

ZONAL LUMEN SUMMARY

Zone	Lumens	%Fixt
0-90	3581	100
90-180	0	0
0-180	3581	100

LUMINANCE DATA (CD/M2)

Vertical Angle	Horizontal Angle		
	0	45	90
45	4039	4053	4068
55	3872	3890	3908
65	3590	3606	3639
75	3050	3090	3117
85	1969	1969	2009

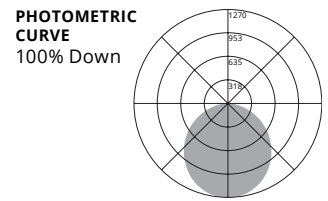

Optics: **Standard Diffuse**
 IES File: **SCE-2L35K-22-SD-L3**
 Lumens: **3581** Wattage: **43**
 Efficacy: **83 LPW**

ZONAL LUMEN SUMMARY

Zone	Lumens	%Fixt
0-90	5668	100
90-180	0	0
0-180	5668	100

LUMINANCE DATA (CD/M2)

Vertical Angle	Horizontal Angle		
	0	45	90
45	6999	6999	6999
55	6743	6743	6743
65	6274	6274	6274
75	5303	5303	5303
85	3209	3209	3209

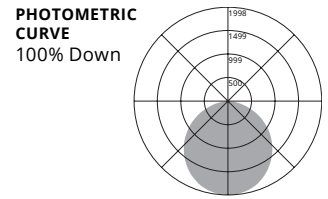

Optics: **Perforated Strip**
 IES File: **SCE-2L35K-14-PS-L3**
 Lumens: **5668** Wattage: **74**
 Efficacy: **77 LPW**

ZONAL LUMEN SUMMARY

Zone	Lumens	%Fixt
0-90	5814	100
90-180	0	0
0-180	5814	100

LUMINANCE DATA (CD/M2)

Vertical Angle	Horizontal Angle		
	0	45	90
45	5180	5121	4912
55	5142	5039	4731
65	5084	4880	4392
75	5005	4562	3705
85	5614	4289	2132

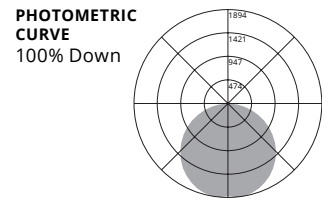

Optics: **Standard Diffuse**
 IES File: **SCE-2L35K-14-SD-L3**
 Lumens: **5814** Wattage: **74**
 Efficacy: **79 LPW**

Photometric performance is measured and scaled in accordance with IESNA LM-79.

DIMENSIONS

Body and Lens

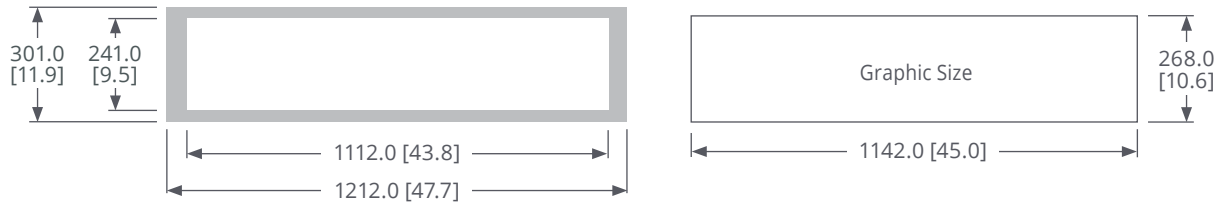
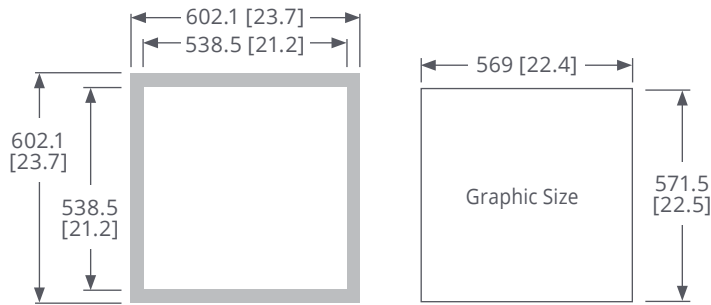
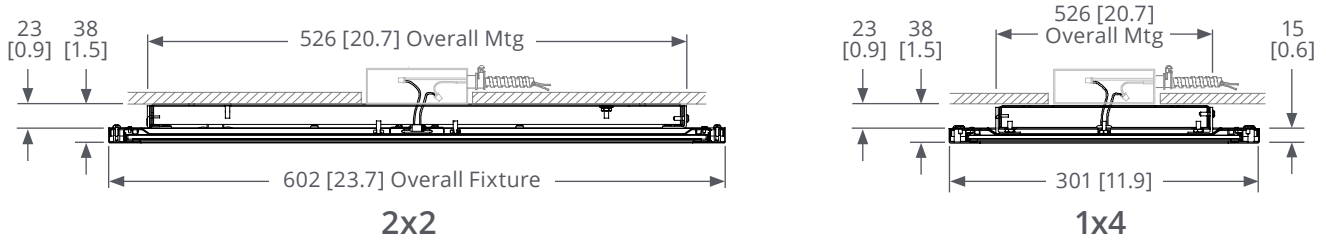

Remote Driver Box

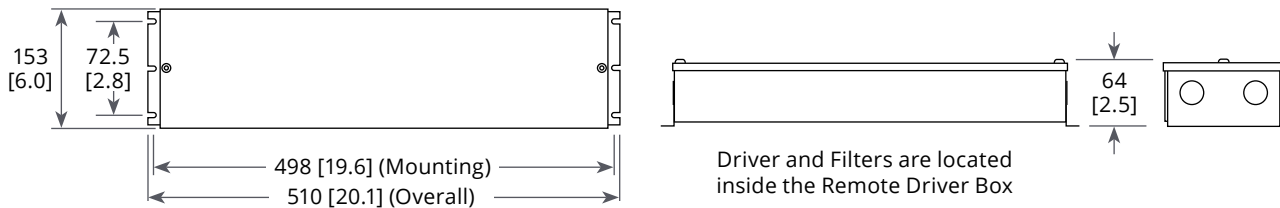

Remote Driver Mounting Maximum Wire Length									
Light Level	Driver Qty.	Driver Current (mA)	Fixture Length	Distance in feet / Wire Gauge					
				22 Ga.	20 Ga.	18 Ga.	16 Ga.	14 Ga.	12 Ga.
L1	1	700	2x2	13	42	67	107	170	280
L2	1	1050	2x2	8	28	45	71	113	180
L3	1	1200	2x2	7	25	39	62	99	157
L4	1	1400	2x2	6	21	34	53	85	135

CROSS SECTIONS | Surface Remote Driver

2x2

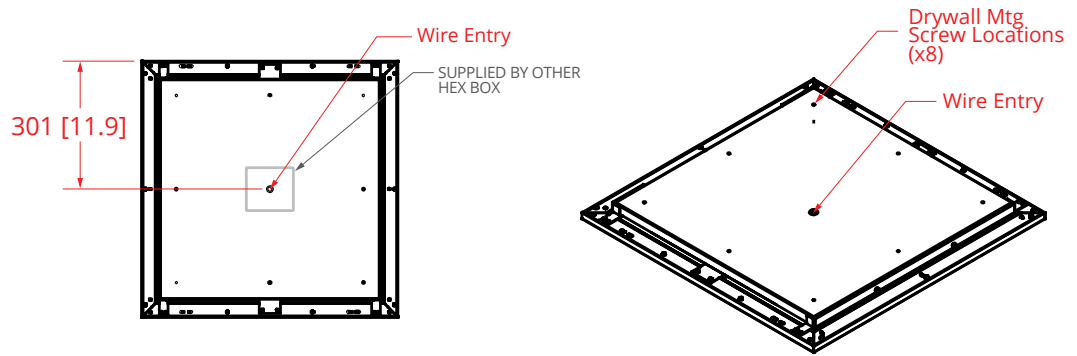
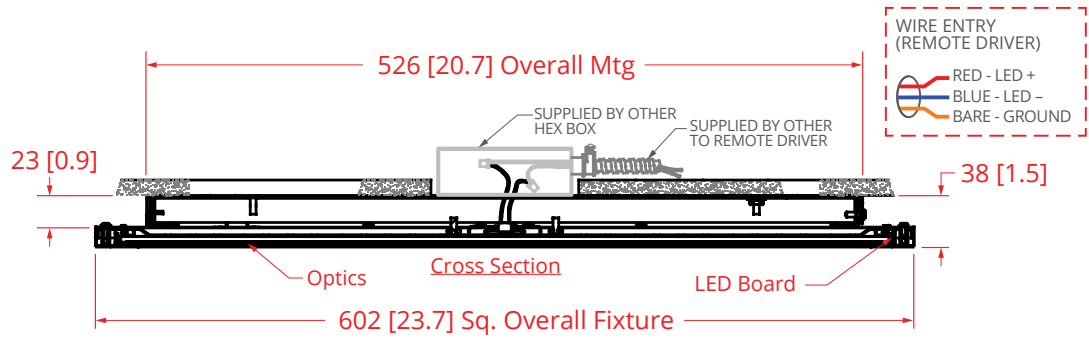

1x4

