

SCENE

LED SCE & SCEM SERIES

Pendant, Recessed & Surface Luminaires

0.6"

 **Metalumen**

Ideas brought to light

SCENE | LED SCE SERIES

Pendant, Recessed & Surface

Introducing the SCENE LED series, a full family of architecturally engineered luminaires equipped with AccuRay® optical technology. Designed to be the thinnest profile in architectural commercial, retail and healthcare lighting, SCENE not only delivers the lumen output and distribution curve required, it also offers visual therapy and branding power to any application.

The carefully constructed mechanical and LED coupling design allows the light beam to continuously be bent in shape for optimal control, all the while completely concealing the LED array for 100% glare-free effect. The exterior profile follows a chic 0.6” profile with brushed corners for an elegant appearance.

The SCENE Series is available in pendant, recessed, and horizontal and vertical surface mounting in 1X4 and 2X2 models. This offers unlimited design flexibility by using those models in any configurations desired to create single or multiple murals for your design. Suited for medical, MRI room or simply any commercial applications in staggered or continuous row mounting.



2x2 SCENE AccuRay Luminaire

Light Level	Wattage	Lumens Delivered	Efficacy (LPW)	Fluorescent Equivalent	Fluorescent Equivalent (W)	Energy Savings*
L4	24	2227	93	2T8/2T5	39	39%
L5	37	3185	86	3T8/3T5	59	38%
L6	43	3581	83	2T5HO	55	23%
L7	51	4090	80	3T5HO	83	39%

* Energy Savings based upon standard lamp/ballast combination using an equivalent FL system (TC4). SCENE's SD lens used in the above comparison chart.

ACCURAY®

The light emitted by the MetaLED mid-flux LEDs is channeled inside Metalumen's AccuRay® optical plane where a precisely controlled micro dot matrix pattern directs, shapes and distributes the light throughout the material. A high performance optical reflector and diffuser further guide and extract the light with superb efficiency and beam control.

- Eliminates Glare
- Maximum uniformity and extremely high vertical cutoff.
- Wide distribution for shortest suspension lengths.
- Designed around the LED engine with precise LED coupling mechanics causing minimal light loss.
- Maximum beam controls right at the source.
- Efficacy improves dramatically.

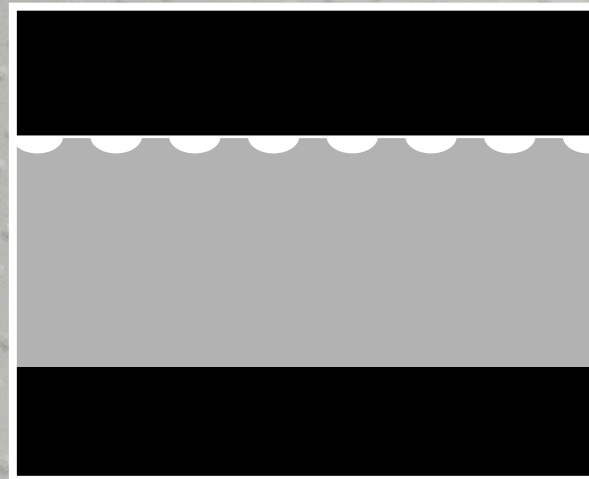

LED

With building code standards improving, luminaires today struggle to meet the criteria necessary for the modern office environment and energy savings. The high efficacy LED system and optical design coupled with standard 0-10V dimming tunable driver allows easy and flexible integration with the latest lighting control systems, occupancy sensors, and daylight harvesting controls. Not only is it a logical transition from FL to LED, but from current LED to LED high efficacious and efficient luminaire system.

DRIVER

Metalumen offers 0-10V dimming drivers as a standard. Dimming range is down to 10%. Dimming drivers are available down to 1%. Power factor @ full load is >90% with a Class 2 rating.



Metalumen's 2-White Tunable LED Board
6500K
2700K

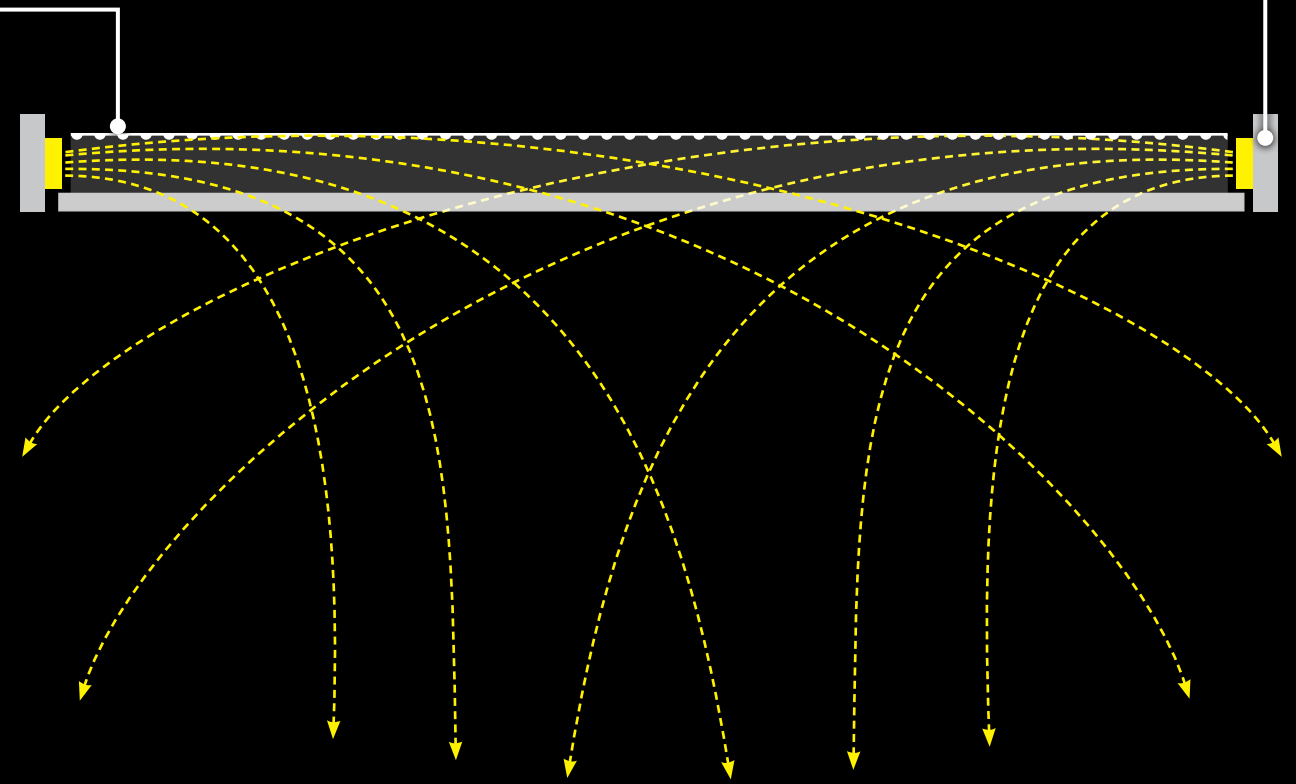

Not to scale. For demonstration purposes only.

PENDANT

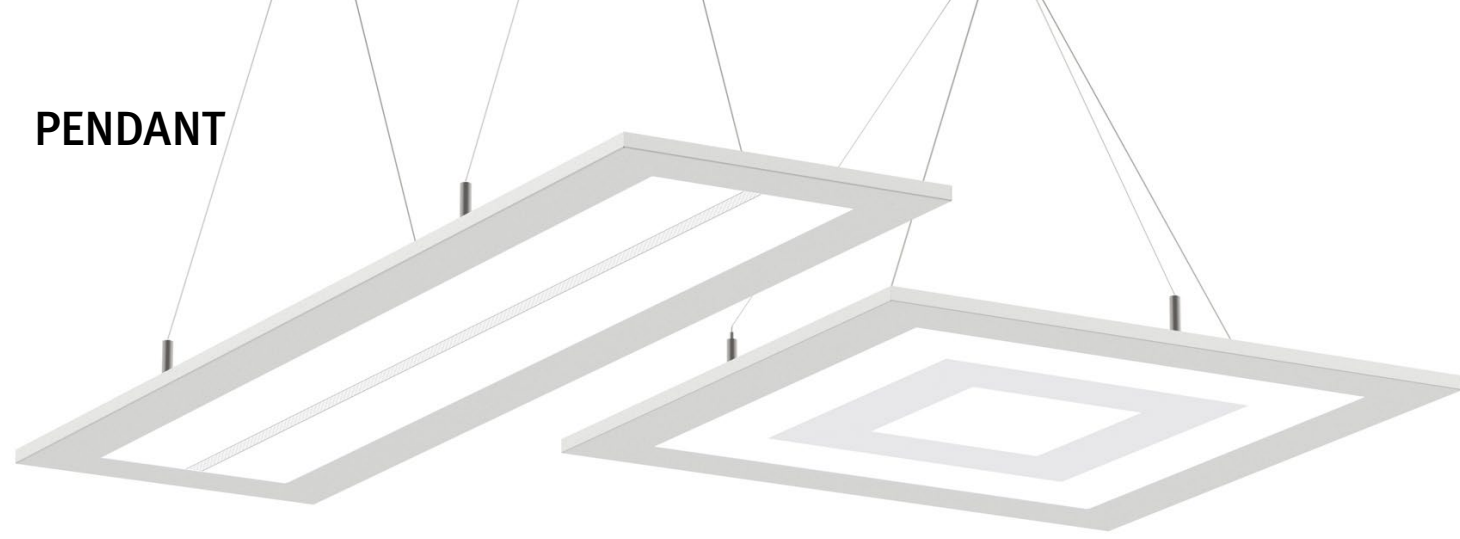

ORDERING LOGIC

Example: **SCE-2L35K-22-QQ-C-L51-P2-2-N-R**

Color Temp	2L30K	3000K
	2L35K	3500K
	2L40K	4000K
	2L50K	5000K
	2LTUN	2-White Tunable (2700K - 6500K)

Size	22	2x2'
	14	1x4'

Optics	PQ	Perforated Square (2x2')
	QQ	Square in Square (2x2')
	CC	Circle in Circle (2x2')
	PS	Perforated Strip (1x4')
	SD	Standard Diffuse (2x2' & 1x4')
	CG	Custom Graphic* (2x2' & 1x4')

*Available for 2x2 @ L7 and 1x4 @ L6 only

Finish	W	White
	C	Custom
	AM	Anti-microbial White Paint

Light Level/Driver	L3	Refer to
	L4	page 19
	L5	for
	L6	Light Levels
	L7	Light Levels

Circuitry	1	1 Circuit
------------------	----------	-----------

Mounting	P1	Power over Aircraft Cable 18"
	P2	Power over Aircraft Cable 48"
	P3	Power over Aircraft Cable 60"

Voltage	1	120V
	2	277V
	3	347V (Consult factory)
	4	Universal

Controls	N	None
	V	Module to 2-Dimmers**
	X	Module to DMX**

** Available with 2-White Tunable option only. Standard DMX system by others required for option "X", or standard 0-10V dimmers - one for intensity and another for CCT mix required for option "V"

Driver Location	R	Remote
	RC	Remote Surface Canopy

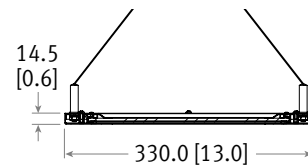

1x4

File Name	SCE-2L35K-14-PS-L5
Luminaire Lumens:	5668
Total Watts:	74
Efficacy:	77 lms/W
Optics Down:	Perforated Strip

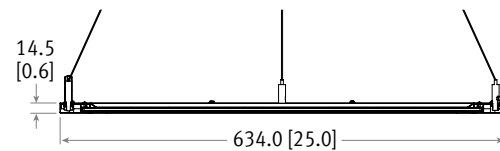
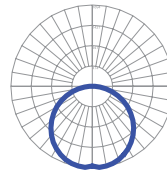

2x2

File Name	SCE-2L35K-22-QQ-L6
Luminaire Lumens:	3251
Total Watts:	43
Efficacy:	76 lms/W
Optics Down:	Square in Square

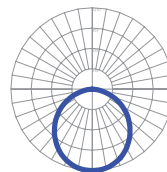

RECESSED

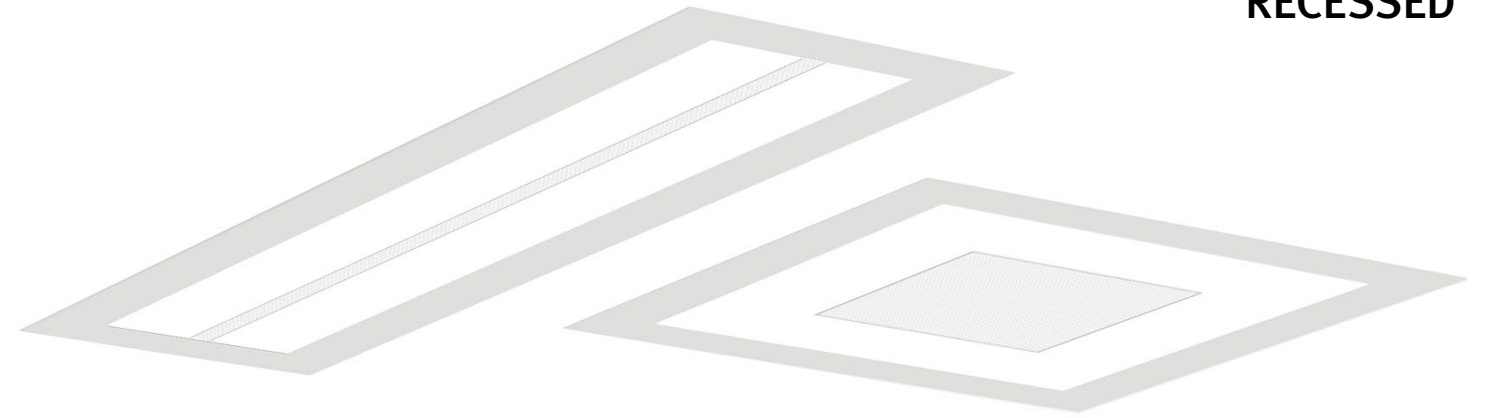

ORDERING LOGIC

Example: **SCE-2L35K-22-PQ-W-L51-D-2-N-N**

Color Temp	2L30K	3000K
	2L35K	3500K
	2L40K	4000K
	2L50K	5000K
	2LTUN	2-White Tunable (2700K - 6500K)

Size	22	2x2'
	14	1x4'

Optics	PQ	Perforated Square (2x2')
	QQ	Square in Square (2x2')
	CC	Circle in Circle (2x2')
	PS	Perforated Strip (1x4')
	SD	Standard Diffuse (2x2' & 1x4')
	CG	Custom Graphic* (2x2' & 1x4')

*Available for 2x2 @ L7 and 1x4 @ L6 only

Finish	W	White
	C	Custom
	AM	Anti-microbial White Paint

Light Level/Driver	L3	Refer to
	L4	page 19
	L5	for
	L6	Light Levels
	L7	Light Levels

Circuitry	1	1 Circuit
------------------	----------	-----------

Mounting	D	Recessed Drywall
	T	Recessed T-Bar

Voltage	1	120V
	2	277V
	3	347V
	4	Universal (120-277V)

Controls	N	None
	V	Module to 2-Dimmers**
	X	Module to DMX**

** Available with 2-White Tunable option only. Standard DMX system by others required for option "X", or standard 0-10V dimmers - one for intensity and another for CCT mix required for option "V"

Driver Location	N	None (Integral)
	R	Remote

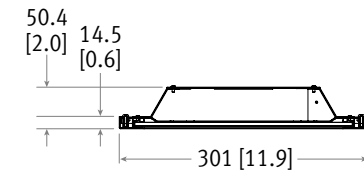

1x4

File Name	SCE-2L35K-14-PS-L5
Luminaire Lumens:	5668
Total Watts:	74
Efficacy:	77 lms/W
Optics Down:	Perforated Strip

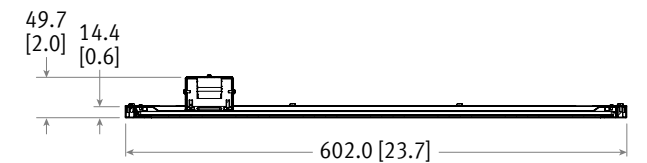
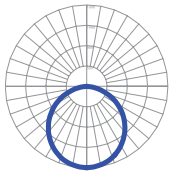

2x2

File Name	SCE-2L35K-22-PQ-L6
Luminaire Lumens:	3316
Total Watts:	43
Efficacy:	77 lms/W
Optics Down:	Perforated Square

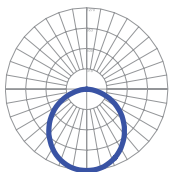

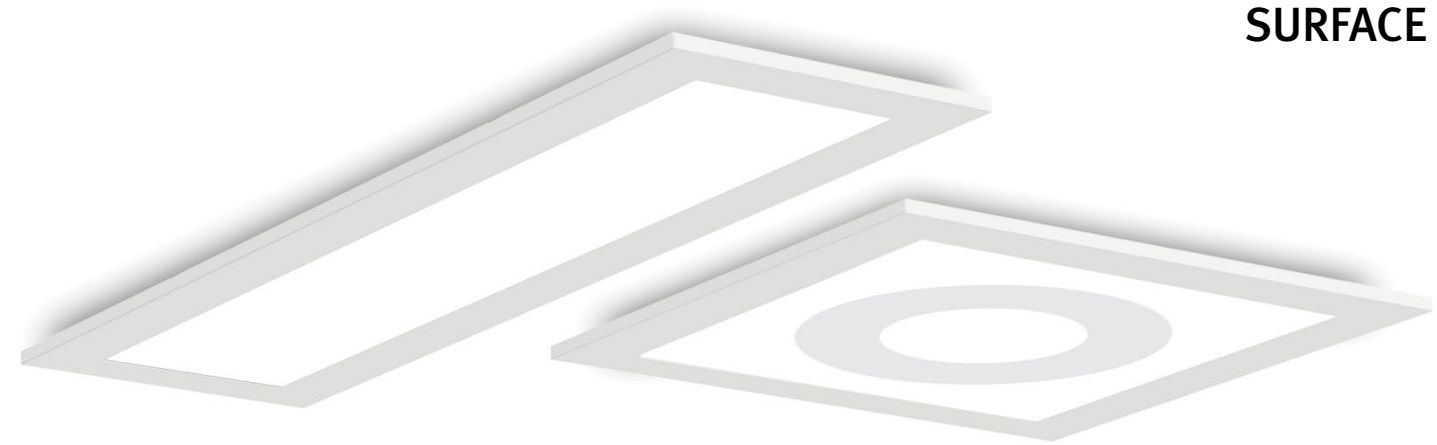

ORDERING LOGIC

Example: **SCE-2L35K-14-SD-W-L51-S-1-N**

Color Temp 2L30K 3000K
 2L35K 3500K
 2L40K 4000K
 2L50K 5000K
 2LTUN 2-White Tunable (2700K - 6500K)

Size 22 2x2'
 14 1x4'

Optics PQ Perforated Square (2x2')
 QQ Square in Square (2x2')
 CC Circle in Circle (2x2')
 PS Perforated Strip (1x4')
 SD Standard Diffuse (2x2' & 1x4')
 CG Custom Graphic* (2x2' & 1x4')
 *Available for 2x2 @ L7 and 1x4 @ L6 only

Finish W White
 C Custom
 AM Anti-microbial White Paint

Light Level/Driver L3 Refer to page 19
 L4 for Light Levels
 L5
 L6
 L7

Circuitry 1 1 Circuit

Mounting S Surface (Remote Driver)
 SI Surface Integral (Integral Driver)
 SC Concrete or Metal surface (Integral Driver)
 (Available for vertical or horizontal mounting)

Voltage 1 120V
 2 277V
 3 347V
 4 Universal (120-277V)

Controls N None
 V Module to 2-Dimmers**
 X Module to DMX**
 **Available with 2-White Tunable option only. Standard DMX system by others required for option "X", or standard 0-10V dimmers - one for intensity and another for CCT mix required for option "V"

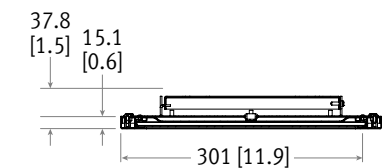

1x4
File Name SCE-2L35K-14-SD-L5
Luminaire Lumens: 5814
Total Watts: 74
Efficacy: 79 lms/W
Optics Down: Standard Diffuse

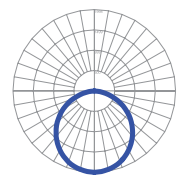

2x2
File Name SCE-2L35K-22-CC-L6
Luminaire Lumens: 3251
Total Watts: 43
Efficacy: 76 lms/W
Optics Down: Circle in Circle

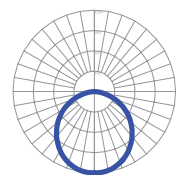

1x4 SCENE AccuRay Luminaire

Light Level	Wattage	Lumens Delivered	Efficacy (LPW)	Fluorescent Equivalent	Fluorescent Equivalent (W)	Energy Savings*
L3	21	2037	97	1T8/1T5	36	42%
L4	48	4068	85	2T8/2T5	72	34%
L5	74	5814	79	3T8/3T5	108	32%
L6	85	6522	77	2T5HO	124	32%

* Energy Savings based upon standard lamp/ballast combination using an equivalent FL system (TC4). SCENE's SD lens used in the above comparison chart.

CONTROL OPTIONS

2-White Tunable Module by Metalumen

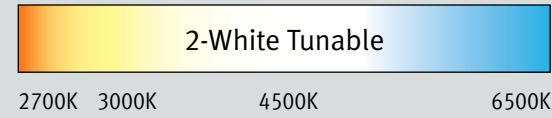

- DMX wired communication via COM ports with up to 512 addresses
- Dimming using a 0-10V dimmer connected to the COM ports

OPTION CODES	Max Output Channels	Max Output Power [W]	Max Channel Power [W]	Control over Driver Dim	0-10V Dim	Dim Minimum %	0-10V-CCT/Intensity
V	2	100	100	•	*		•
X	2	100	100	•	1%	•	

* = Dim minimum limited by driver specs

WIRING DIAGRAM

Dual 0-10V Dimmer Configuration

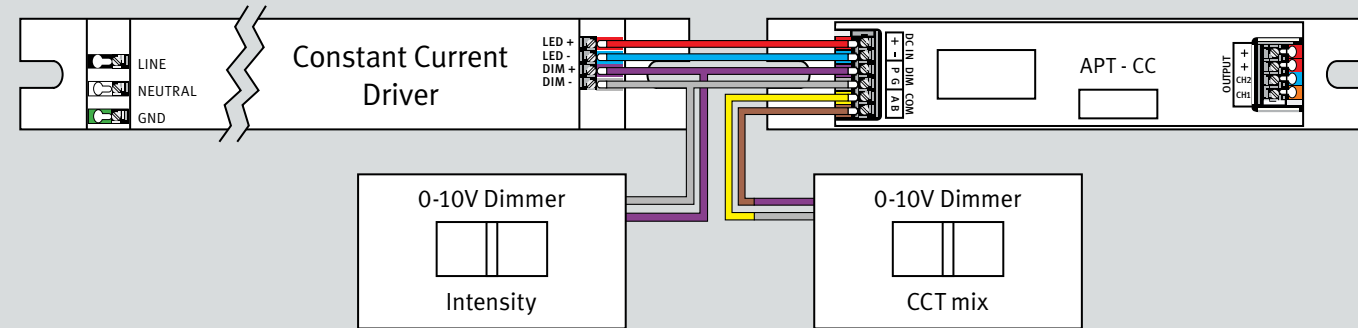

DMX Configuration

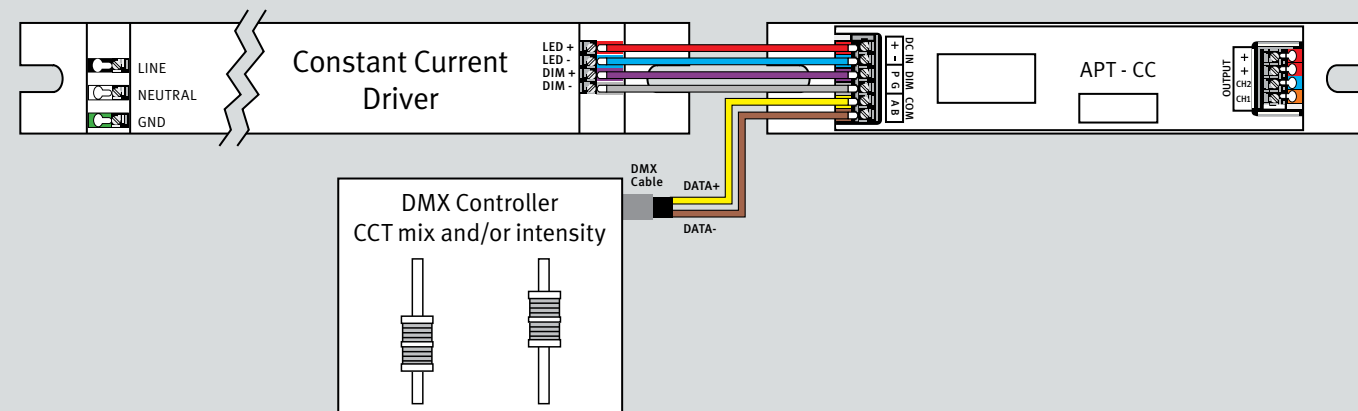

2-White Tunable Control Options (By Others):

- Standard 512 channel DMX system by Lutron, Fulham, etc... (requires complete DMX system)
- Standard 0-10V dimmers: one for Intensity and another for CCT mix.

MEDICAL CENTRE CALCULATION

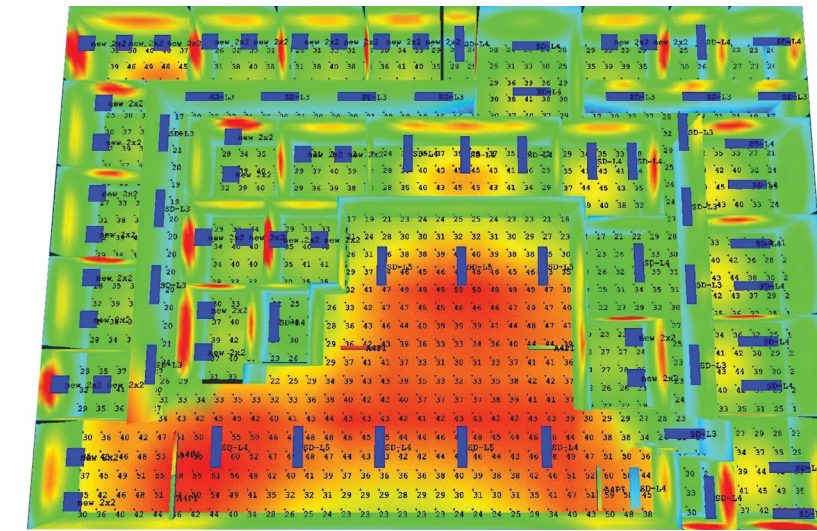

Room Size: 78.4' x 53.8'
Ceiling Height: 10'

Avg. Horizontal Light Level	40 FC
Avg/Min	1.24
Max/Min	1.52



SYSTEM ENERGY & MAINTENANCE SAVINGS

Annual Operating Cost Energy & Lamp Maintenance

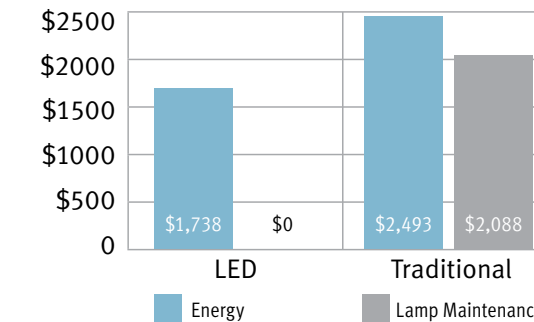

System Energy & Maintenance Cost Summary

	LED	Traditional
Total Initial Fixture/Installation Cost	\$28,361	\$25,075
Total System kW	3.79	544
Annual kWh	13,841	19,856
Cost of Energy per kWh	\$0.120	\$0.120
kWh Inflation Rate (%/yr)	1.00%	1.00%
Average Annual Energy Cost	\$1,738	\$2,493
Average Annual Maintenance Cost	\$0	\$2,088
Average Annual Energy & Maintenance Costs	\$1,738	\$4,580
Average Annual Energy & Maintenance Savings	\$2,843	

Payback Analysis

Average Annualized Savings Per Year

Annual Energy Savings	\$755
Annual Lamp Maintenance Savings	\$2,088
Annual Combined Savings	\$2,843
Cost of Waiting (Monthly)	\$237
Simple Payback (years)	1.16
IRR (%)	86%
10 Year Cash Flow (Energy & Lamp Maintenance)	\$25,142

	Savings		Cost/year	
	Annual	Cumulative	LED	Traditional
1st Year	\$722	\$722	\$1,661	\$2,383
5th Year	\$2,824	\$10,834	\$1,694	\$4,518
10th Year	\$2,843	\$25,142	\$1,738	\$4,580
10 Year Total	\$28,428		\$17,377	\$45,805

*** Calculation is based on actual LED fixture used in comparison to a T-5 28W FL fixture. Assumptions are \$0.12 per kWh and 10 operating Hours/day (10h @ full power). These are estimated savings only. Annual and monthly savings are based on a number of variables and assumptions that could change over time. The actual savings derived by our firm may be higher or lower. Metalumen's business does not imply a warranty of performance or savings as calculated and shown within this document.

SCENE | LED SCEN SERIES

Surface & Recessed

With ambiance, visual interest, uplifting energy and soothing influence, these luminaires combine leading edge technology with good lighting practice. Studies have shown the positive effect of imagery, especially in healthcare facilities, on human wellness and reduction of anxiety and stress levels. This methodology is used in patient rooms and MRI facilities to divert patients' attention during treatment or examination. SCENE offers few standard patterns and opens the custom imagery to anything desired by the application - simply supply us with any high resolution image and we will make it happen.



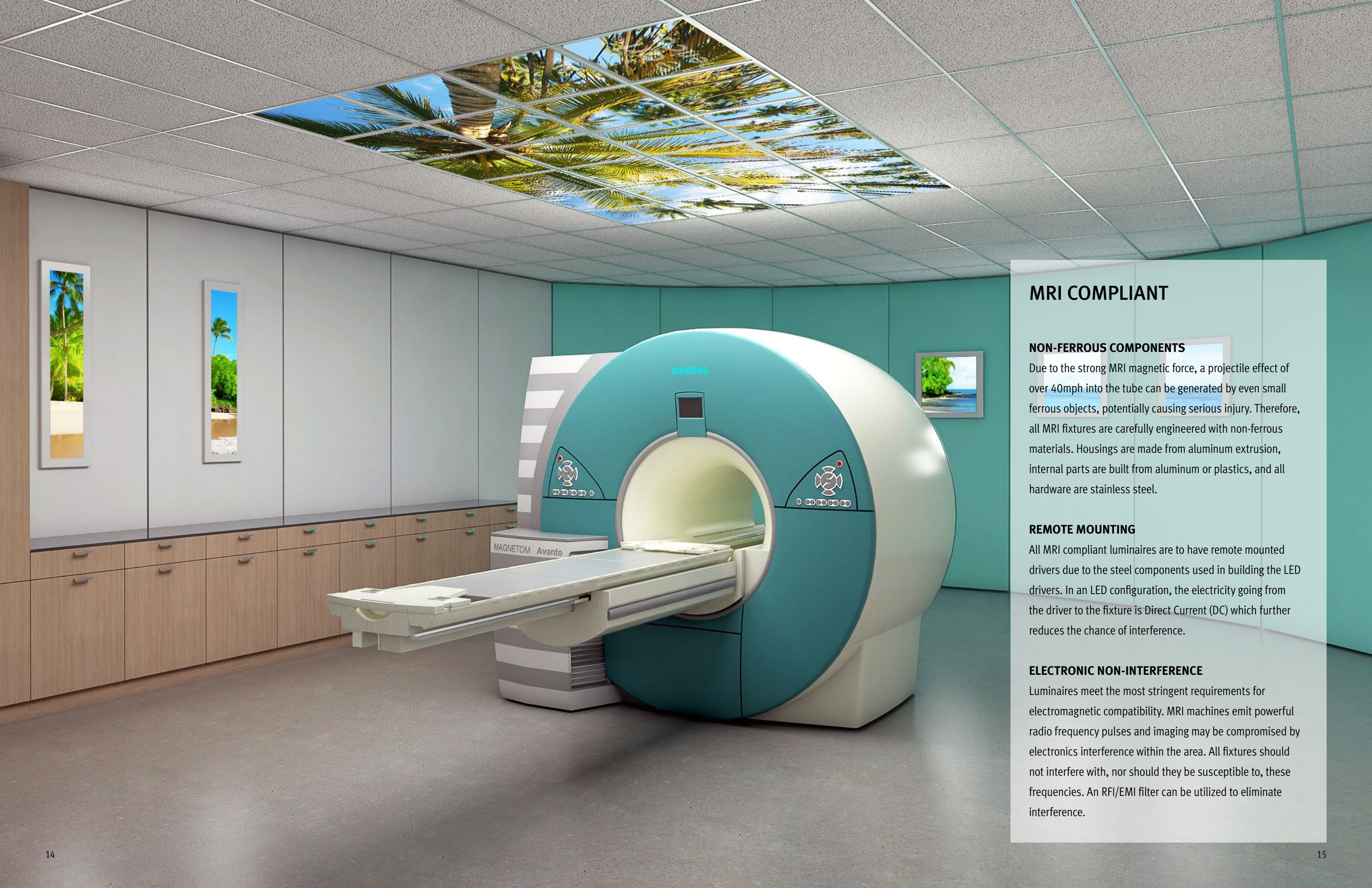

MRI COMPLIANT

NON-FERROUS COMPONENTS

Due to the strong MRI magnetic force, a projectile effect of over 40mph into the tube can be generated by even small ferrous objects, potentially causing serious injury. Therefore, all MRI fixtures are carefully engineered with non-ferrous materials. Housings are made from aluminum extrusion, internal parts are built from aluminum or plastics, and all hardware are stainless steel.

REMOTE MOUNTING

All MRI compliant luminaires are to have remote mounted drivers due to the steel components used in building the LED drivers. In an LED configuration, the electricity going from the driver to the fixture is Direct Current (DC) which further reduces the chance of interference.

ELECTRONIC NON-INTERFERENCE

Luminaires meet the most stringent requirements for electromagnetic compatibility. MRI machines emit powerful radio frequency pulses and imaging may be compromised by electronics interference within the area. All fixtures should not interfere with, nor should they be susceptible to, these frequencies. An RFI/EMI filter can be utilized to eliminate interference.

THE SCENE IS SUITABLE FOR A VARIETY OF MEDICAL SETTINGS:

- Waiting Rooms
- Corridors
- ICU
- MRI rooms
- Dentist offices
- Reception areas
- Lobbies
- Cafeterias



RECESSED ORDERING LOGIC

Example: SCEM-2L35K-22-QQ-AM-L51-D-2-V-N

Color Temp	2L30K	3000K
	2L35K	3500K
	2L40K	4000K
	2L50K	5000K
	2LTUN	2-White Tunable (2700K - 6500K)
Size	22	2x2'
	14	1x4'
Optics	PQ	Perforated Square (2x2')
	QQ	Square in Square (2x2')
	CC	Circle in Circle (2x2')
	PS	Perforated Strip (1x4')
	SD	Standard Diffuse (2x2' & 1x4')
	CG	Custom Graphic* (2x2' & 1x4')
		<small>* Available for 2x2 @ L7 and 1x4 @ L6 only</small>
Finish	AM	Anti-microbial White Paint
Light Level/Driver	L3	Refer to
	L4	page 19
	L5	for
	L6	Light Levels
	L7	
Circuitry	1	1 Circuit
Mounting	D	Recessed Drywall
	T	Recessed T-Bar
Voltage	1	120V
	2	277V
	3	347V
	4	Universal (120 - 277V)
Controls	N	None
	V	Module to 2-Dimmers**
	X	Module to DMX **
		<small>** Available with 2-White Tunable option only. Standard DMX system by others required for option "X", or standard 0-10V dimmers - one for intensity and another for CCT mix required for option "V"</small>
Options	N	None
	RF	RFI (Radio Frequency Interference) / EMI (Electromagnetic Interference) Filter

SURFACE ORDERING LOGIC

Example: SCEM-2L35K-22-QQ-AM-L51-S-2-N-RF

Color Temp	2L30K	3000K
	2L35K	3500K
	2L40K	4000K
	2L50K	5000K
	2LTUN	2-White Tunable (2700K - 6500K)
Size	22	2x2'
	14	1x4'
Optics	PQ	Perforated Square (2x2')
	QQ	Square in Square (2x2')
	CC	Circle in Circle (2x2')
	PS	Perforated Strip (1x4')
	SD	Standard Diffuse (2x2' & 1x4')
	CG	Custom Graphic* (2x2' & 1x4')
		<small>* Available for 2x2 @ L7 and 1x4 @ L6 only</small>
Finish	AM	Anti-microbial White Paint
Light Level/Driver	L3	Refer to
	L4	page 19
	L5	for
	L6	Light Levels
	L7	
Circuitry	1	1 Circuit
Mounting	S	Surface
Voltage	1	120V
	2	277V
	3	347V
	4	Universal (120 - 277V)
Controls	N	None
	V	Module to 2-Dimmers**
	X	Module to DMX **
		<small>** Available with 2-White Tunable option only. Standard DMX system by others required for option "X", or standard 0-10V dimmers - one for intensity and another for CCT mix required for option "V"</small>
Options	N	None
	RF	RFI (Radio Frequency Interference) / EMI (Electromagnetic Interference) Filter

SPECIFICATIONS

	SCE	SCEM
HOUSING	Body is constructed with 22 gauge cold rolled steel, 20 gauge aluminum and welded seams.	100% aluminum body with welded seams and stainless steel hardware.
OPTICAL SYSTEM	The light emitted from the MetalLED mid-flux LEDs is channeled inside Metalumen's AccuRay® optical plane where a precisely controlled micro dot matrix pattern directs, shapes and distributes the light throughout the material. A high performance optical reflector and diffuser further guide and extract the light with superb efficiency and beam control. Standard graphics are available. Custom graphics must be provided by customer in PDF format.	
CRI	83+ (3500K) (80 minimum) Consult factory for 90+ CRI	
LUMEN MAINTENANCE	At an ambient operating temperature of 25°C the LED lifetime expectancy = < 60 000hrs at L70.	
FINISH	Matte powder coat white paint (91% reflectance). Anti-microbial white paint. Consult factory for custom finish.	Highly reflective, antimicrobial white paint
MOUNTING	Pendant Recessed Surface	Recessed Surface
DRIVER	Metalumen offers dimming drivers as a standard on our entire LED product offering at 0-10V. Dimming is 10%-100% range Power factor is < 90% with a Class 2 rating.	
APPROVALS	Certified to NRTL safety and IES Recommendation testing standards. All components are UL/CSA/QPS recognized or listed, RoHS, LM79, LM80 and LM82 compliant.	
ENVIRONMENT	Suitable for dry locations.	Suitable for dry or damp locations.

DIMENSIONS

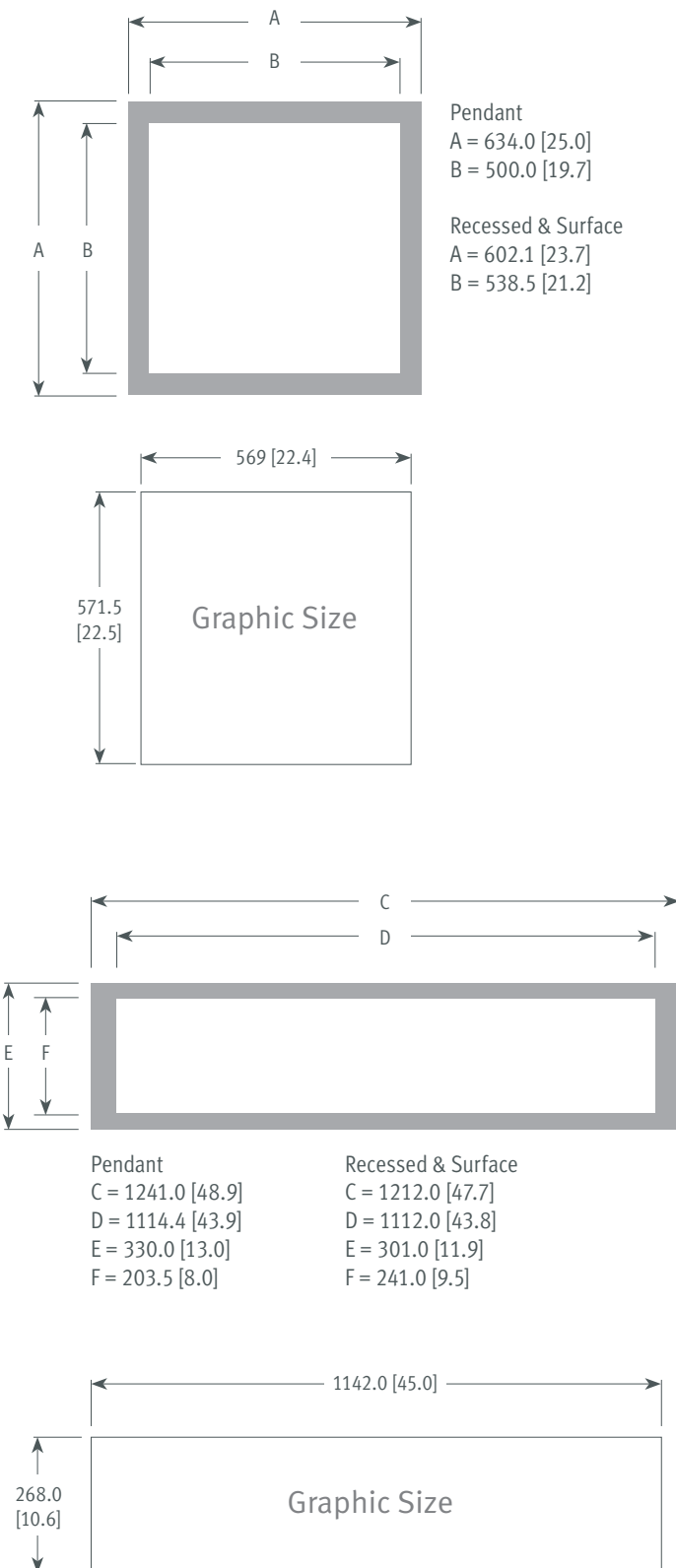

LUMINAIRE WATTAGE AND OUTPUT SPECIFICATION

Light Level	Perforated Square (PQ)			Square in Square (QQ)			Circle in Circle (CC)			Standard Diffuse (SD)		
	Wattage	Lumens Delivered	Efficacy (LPW)	Wattage	Lumens Delivered	Efficacy (LPW)	Wattage	Lumens Delivered	Efficacy (LPW)	Wattage	Lumens Delivered	Efficacy (LPW)
L4 =	24	2053	86	24	2042	85	24	2040	85	24	2227	93
L5 =	37	2947	80	37	2816	76	37	2816	76	37	3185	86
L6 =	43	3316	77	43	3251	76	43	3251	76	43	3581	83
L7 =	51	3794	74	51	3852	76	51	3846	75	51	4090	80

Light Level	Perforated Strip (PS)			Standard Diffuse (SD)		
	Wattage	Lumens Delivered	Efficacy (LPW)	Wattage	Lumens Delivered	Efficacy (LPW)
L3 =	21	1905	91	21	2037	97
L4 =	48	3727	78	48	4068	85
L5 =	74	5668	77	74	5814	79
L6 =	85	6469	76	85	6522	77

STANDARD OPTICS



PQ - Perforated Square

QQ - Square in Square

CC - Circle In Circle

SD - Standard Diffuse



PS - Perforated Strip

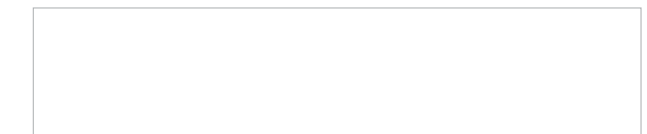

SD - Standard Diffuse

WARRANTY

Metalumen will warrant defective luminaires for 5 years from date of purchase. Warranty is valid if luminaire is installed and used according to specification. If defective, Metalumen will send replacement boards or drivers at no cost along with detailed replacement instructions and instructions on how to return defective components to Metalumen.





**SCENE
LED SCE & SCEM Series
Pendant, Surface & Recessed Luminaires**

**Metalumen Manufacturing Inc.
570 Southgate Drive
Guelph, Ontario, Canada
N1G 4P6**

**Toll Free: 1.800.621.6785
Tel: 1.519.822.4381
Fax: 1.519.822.4589**

**Mailing Address:
PO Box 1779
Guelph, Ontario, Canada
N1H 6Z9**

www.metalumen.com

All dimensions are nominal and subject to tolerances. We reserve the right to make changes that will not alter installed appearance, function or performance. These designs remain the property of Metalumen. We reserve the exclusive right to reproduce them and to manufacture the items illustrated herein. Some combinations may not be available, consult factory. Metalumen is a registered trademark. R2-20180605

Copyright ©2016 Metalumen Manufacturing Inc.
All rights reserved.