

RAIL 4 WET S4WD

RECESSED FLANGELESS . DIRECT

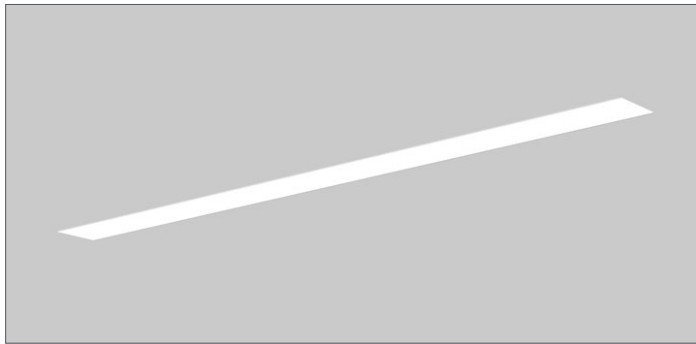

- Efficacy up to 122 LPW
- Wet location and IP54 rated
- Continuous direct optics with no breaks
- Constructed of non-corrosive components
- Standard natatorium powder coat finish



| | | | |
|---------------------|--|--------------------|--|
| PART #: | | DATE: | |
| PREP BY: | | QTY: | |
| PROJECT: | | NOTES: | |
| APPROVAL SIGNATURE: | | DATE (DD/MM/YYYY): | |

| PERFORMANCE SUMMARY @ 3500K | | Meta Blanc MB | Luma Span LS | Luma Asym. LA | Polycarbonate PC |
|-----------------------------|--------|---------------|--------------|---------------|------------------|
| Light Level | | 50 | 50 | 50 | 50 |
| Lumens per foot | 80 CRI | 574 | 522 | 525 | 585 |
| | 90 CRI | 502 | 457 | 459 | 512 |
| Wattage per foot | | 5.7 | 4.7 | 4.4 | 5.8 |
| Efficacy | 80 CRI | 100 | 112 | 118 | 102 |
| | 90 CRI | 88 | 97 | 104 | 88 |
| L70 Estimate (h) | | ≥ 60,000 hrs | | | |

See complete Light Level Performance and Photometric Data on p2

OTHER RAIL WET SERIES PRODUCTS

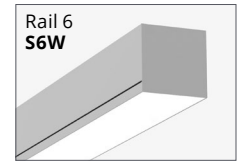
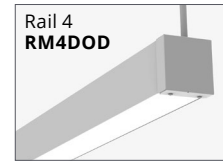

ORDERING LOGIC

Example Part Number: S4WD-35K-8-MB-NW-1001-DF-3-00

| | | | | | | | | | | | | | | | |
|--|---|---|--|--|--|--|---|--|----|--|----|---|--|--|--|
| S4WD | | DF | | | | | | | | | | | | | |
| 1 | 2 | 3 | 4 | 5 | 6 | 7 | 8 | 9 | 10 | 11 | 12 | | | | |
| 1. SERIES S4WD Direct | 2. COLOR TEMP 30K 3000K 35K 3500K 40K 4000K | 3. LENGTH 2 2 ft 3 3 ft 4 4 ft 5 5 ft 6 6 ft 7 7 ft 8 8 ft 9 9 ft 10 10 ft 11 11 ft 12 12 ft RA Continuous Rows (Replace "A" with length in feet) C Custom Length* | 4. PATTERN ¹ GA Square GAxB Rectangle UAxBxC U-Shape LAxB L-Shape C Custom Pattern* _ None (leave space empty) | 5. OPTICS MB Meta Blanc IK10 PC Polycarbonate IK10 LS Luma Span (Batwing) LA Luma Asymmetric | 6. FINISH NSA Satin Aluminum NW White NB Black NC Custom Specify RAL: | | | | | | | | | | |
| 90 CRI is available under OPTIONS | | Standard Patterns Minimum Lengths Square: A=4 ft min., B=4 ft min. Rectangle: A=4 ft min., B=4 ft min. U-Shape: A=3 ft min., B=4 ft min., C=3 ft min. L-Shape: A=3 ft min., B=3 ft min. | | MB: Acrylic opal diffuse lens LS, LA: Acrylic high output semi-diffuse lens PC: Semi-diffuse lens | | See Photometric Data on p2 | | | | | | | | | |
| Custom Patterns* Lengths and a drawing of custom pattern are required on page 3 | | Select corner: Outside 90° Inside 90° | | 7. LIGHT LEVEL / DRIVER 35 350 lm/f 75 750 lm/f 50 500 lm/f 100 1000 lm/f C Custom Range. Specify lumens: (Total lumens between 350-1000 at 50 lm intervals) Select Driver below. See Light Level Performance chart on p2. | | 8. CIRCUITRY 1 1 Circuit EM Emergency / Night Light B Emergency Battery Pack* (remote mounted) (Limited to ambient temperatures down to 0°C) | | 9. MOUNTING DF Recessed Drywall Flangeless | | 10. VOLTAGE 1 120 V 2 277 V 3 347 V 4 UNV (120 - 277V) | | 11. CONTROLS OO Outdoor Occupancy Sensor DD Outdoor Dusk to Dawn Sensor _ None (leave space empty) | | 12. OPTIONS 90 90 CRI, High R9 _ None (leave space empty) | |

*Consult factory. | ¹ Pattern record drawings showing mounting locations will be sent out upon order.

- Select Driver: Factory option 0-10V, 1% Dimming
 LHE Lutron H-Series Hi-lume 1% EcoSystem LED Driver
 LSE Lutron 5-Series EcoSystem LED Driver
 Consult factory for -40 drivers.

LIGHT LEVEL PERFORMANCE & PHOTOMETRIC DATA

3500K, 80 CRI, 0-10V Dimming (Standard)

| Light Level | Meta Blanc (MB) | | | Polycarbonate (PC) | | | Luma Span (LS) | | | Luma Asymmetric (LA) | | | |
|----------------|------------------------------|------------------|----------------|--------------------|------------------|----------------|-----------------|------------------|----------------|----------------------|------------------|----------------|--|
| | Lumens per foot | Wattage per foot | Efficacy (LPW) | Lumens per foot | Wattage per foot | Efficacy (LPW) | Lumens per foot | Wattage per foot | Efficacy (LPW) | Lumens per foot | Wattage per foot | Efficacy (LPW) | |
| 35 | 381 | 3.9 | 99 | 388 | 3.9 | 101 | 363 | 3.2 | 115 | 364 | 3.0 | 122 | |
| 50 | 574 | 5.7 | 100 | 585 | 5.8 | 102 | 522 | 4.7 | 112 | 525 | 4.4 | 118 | |
| 75 | 790 | 8.1 | 97 | 807 | 8.1 | 99 | 772 | 6.9 | 111 | 772 | 6.4 | 121 | |
| 100 | 1090 | 11.8 | 93 | 1115 | 11.7 | 95 | 1025 | 9.4 | 109 | 1016 | 8.8 | 116 | |
| Light Level 75 | IES File | S4WD-35K-4-MB-75 | | | S4WD-35K-4-PC-75 | | | S4WD-35K-4-LS-75 | | | S4WD-35K-4-LA-75 | | |
| | Distribution % (Down / Up) | 100 / 0 | | | 100 / 0 | | | 100 / 0 | | | 100 / 0 | | |
| | Zonal Lumens (0-90 / 90-180) | 3156 / 0 | | | 3227 / 0 | | | 3086 / 0 | | | 3088 / 0 | | |
| | Distribution Curve | | | | | | | | | | | | |

Lumen Adjustment Factor (Standard)

| Color Temp | 80 CRI | 90 CRI |
|------------|--------|--------|
| 3000K | 0.984 | 0.880 |
| 3500K | 1.000 | 0.875 |
| 4000K | 1.032 | 0.879 |

Metalumen's light level performance metrics are subject to manufacturers component tolerances.

CROSS SECTION

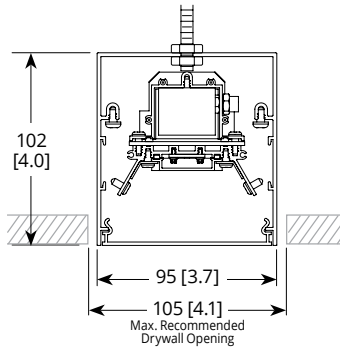

WIRING

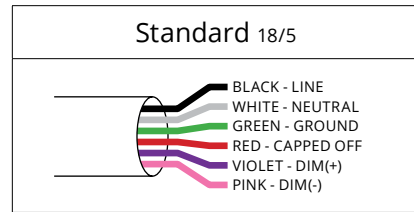

SPECIFICATIONS

Due to the Continuous Improvement Policy at Metalumen, we reserve the right to change our specifications without notice.

Housing: Rigid extruded aluminum body, 2.0mm (0.08") nominal wall thickness. Aluminum formed end caps.
Optical System: Metalumen luminaires are designed to utilize leading edge LED technology combined with luminaire optimized reflectors and our custom diffusers, resulting in industry leading optical performance.
CRI: 83+ for 3500K, 80 minimum for all

CCTs in standard configurations.
Lumen Maintenance: Minimum 50,000h with TM-21 lumen maintenance of 85% @ 25°C ambient temperature (calculated based on IESNA LM-80-08 LED test data). L70: ≥ 60 000hrs.
Finish: Standard natatorium powder coated finish in satin aluminum, white and black. Exceeds 4000 salt spray hours (ASTM B117). For custom colors,

contact factory.
Weight: 3 lb/ft
Mounting: Mounting brackets provided.
Drivers: Metalumen offers dimming* drivers as a standard on our entire LED product offering at 0-10V. Dimming range is 1%-100%. Power factor is > 90%. Class 2 rating. Drivers are integral. Consult factory for -40 drivers.

Approvals: All components are UL/ CSA/QPS recognized or listed. RoHS compliant. This product is cULus listed.
Environment: Suitable for wet locations -22°F / -30°C start ambient temperature. Suitable for natatorium environments.

**Standard drivers compatible with passive/sinking dimmers. Please contact Metalumen if active/sourcing dimmer support is required.*

WARRANTY

Metalumen will warrant defective luminaires for 5 years from date of purchase. Warranty is valid if luminaire is installed and used according to specification. If defective, Metalumen will send replacement boards or drivers at no cost along with detailed replacement instructions and instructions on how to return defective components to Metalumen.

PATTERNS

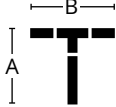
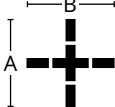
| | | |
|-------------------------------|---|---|
| Select Pattern: | <input type="checkbox"/> T-SHAPE (C) | <input type="checkbox"/> CROSS / X-SHAPE (C) |
| Pattern Configuration |  |  |
| Indicate Desired Lengths (ft) | Consult Factory | |
| Minimum Lengths | A = 3 ft B = 6 ft | A = 6 ft B = 6 ft |

A custom pattern configuration drawing is required in the grid below

Approval drawings will be sent out upon order showing mounting locations.

