

# RAIL 4 WET S4WD

WALL VERTICAL . DIRECT

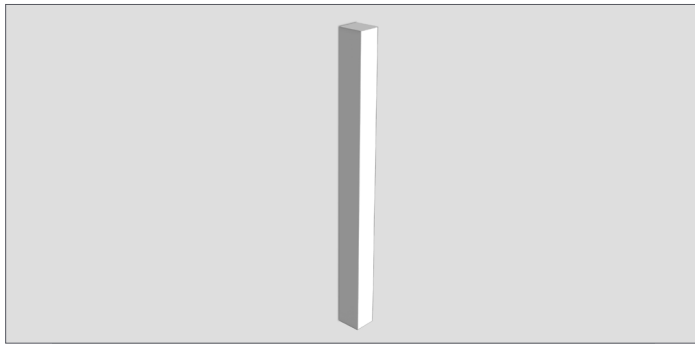

- Efficacy up to 122 LPW
- Wet location and IP54 rated
- Continuous direct optics with no breaks
- Constructed of non-corrosive components
- Standard natatorium powder coat finish



PART #:	
PREP BY:	DATE:
PROJECT:	QTY:
NOTES:	
APPROVAL SIGNATURE:	DATE (DD/MM/YYYY):

PERFORMANCE SUMMARY @ 3500K		Meta Blanc MB	Luma Span LS	Luma Asym. LA	Polycarbonate PC
Light Level		<b>50</b>	<b>50</b>	<b>50</b>	<b>50</b>
Lumens per foot	80 CRI	574	522	525	585
	90 CRI	502	457	459	512
Wattage per foot		5.7	4.7	4.4	5.8
Efficacy	80 CRI	100	112	118	102
	90 CRI	88	97	104	88
L70 Estimate (h)		≥ 60,000 hrs			

See complete Light Level Performance and Photometric Data on p2

## OTHER RAIL WET SERIES PRODUCTS

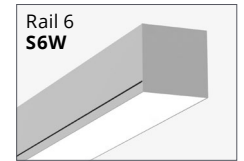
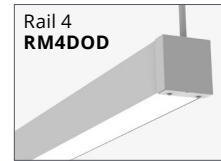

## ORDERING LOGIC

Example Part Number: S4WD-35K-8-MB-NW-1001-WV-3-00

S4WD								WV											
1	2	3	4	5	6	7	8	9	10	11									
1. SERIES <b>S4WD</b> Direct	2. COLOR TEMP <b>30K</b> 3000K <b>35K</b> 3500K <b>40K</b> 4000K  90 CRI is available under OPTIONS	3. LENGTH <b>2</b> 2 ft <b>8</b> 8 ft <b>3</b> 3 ft <b>9</b> 9 ft <b>4</b> 4 ft <b>10</b> 10 ft <b>5</b> 5 ft <b>11</b> 11 ft <b>6</b> 6 ft <b>12</b> 12 ft <b>7</b> 7 ft <b>RA</b> Continuous Rows (Replace "A" with length in feet) <b>C</b> Custom Length*		4. OPTICS <b>MB</b> Meta Blanc <b>IK10</b> <b>PC</b> Polycarbonate <b>IK10</b> <b>LS</b> Luma Span (Batwing) <b>LA</b> Luma Asymmetric  <b>MB:</b> Acrylic opal diffuse lens <b>LS, LA:</b> Acrylic high output semi-diffuse lens <b>PC:</b> Semi-diffuse lens  See Photometric Data on p2		5. NATATORIUM FINISH <b>NSA</b> Satin Aluminum <b>NW</b> White <b>NB</b> Black <b>NC</b> Custom Specify RAL:		6. LIGHT LEVEL / DRIVER <b>35</b> 350 lm/f <b>50</b> 500 lm/f <b>75</b> 750 lm/f <b>100</b> 1000 lm/f <b>C</b> Custom Range Specify lumens:  (Total lumens between 350-1000 at 50 lm intervals)  Select Driver below. See Light Level Performance chart on p2.		7. CIRCUITRY <b>1</b> 1 Circuit <b>EM</b> Emergency / Night Light <b>B</b> Emergency Battery Pack* (remote mounted) (Limited to ambient temperatures down to 0°C)		8. MOUNTING <b>WV</b> Wall - Vertical with lens facing out		9. VOLTAGE <b>1</b> 120 V <b>2</b> 277 V <b>3</b> 347 V <b>4</b> UNV (120 - 277V)		10. CONTROLS <b>OO</b> Outdoor Occupancy Sensor <b>DD</b> Outdoor Dusk to Dawn Sensor _ None (leave space empty)		11. OPTIONS <b>90</b> 90 CRI, High R9 _ None (leave space empty)	

\*Consult factory.

- Select Driver:  Factory option 0-10V, 1% Dimming  
 **LHE** Lutron H-Series Hi-lume 1% EcoSystem LED Driver  
 **LSE** Lutron 5-Series EcoSystem LED Driver  
 Consult factory for -40 drivers.

## LIGHT LEVEL PERFORMANCE & PHOTOMETRIC DATA

3500K, 80 CRI, 0-10V Dimming (Standard)

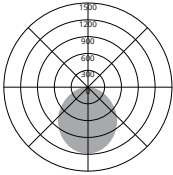
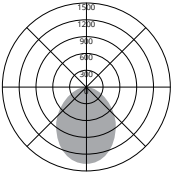
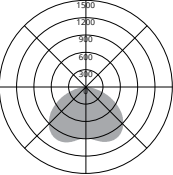
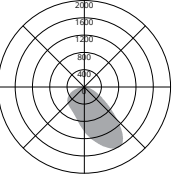
Light Level	Meta Blanc (MB)			Polycarbonate (PC)			Luma Span (LS)			Luma Asymmetric (LA)			
	Lumens per foot	Wattage per foot	Efficacy (LPW)	Lumens per foot	Wattage per foot	Efficacy (LPW)	Lumens per foot	Wattage per foot	Efficacy (LPW)	Lumens per foot	Wattage per foot	Efficacy (LPW)	
<b>35</b>	381	3.9	99	388	3.9	101	363	3.2	115	364	3.0	122	
<b>50</b>	574	5.7	100	585	5.8	102	522	4.7	112	525	4.4	118	
<b>75</b>	790	8.1	97	807	8.1	99	772	6.9	111	772	6.4	121	
<b>100</b>	1090	11.8	93	1115	11.7	95	1025	9.4	109	1016	8.8	116	
Light Level 75	IES File	S4WD-35K-4-MB-75			S4WD-35K-4-PC-75			S4WD-35K-4-LS-75			S4WD-35K-4-LA-75		
	Distribution % (Down / Up)	100 / 0			100 / 0			100 / 0			100 / 0		
	Zonal Lumens (0-90 / 90-180)	3156 / 0			3227 / 0			3086 / 0			3088 / 0		
	Distribution Curve												

### Lumen Adjustment Factor (Standard)

Color Temp	80 CRI	90 CRI
3000K	0.984	0.880
3500K	1.000	0.875
4000K	1.032	0.879

Metalumen's light level performance metrics are subject to manufacturers component tolerances.

### CROSS SECTION

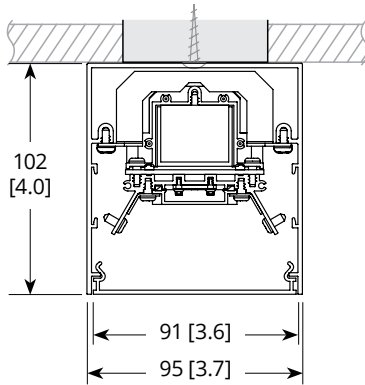

### WIRING

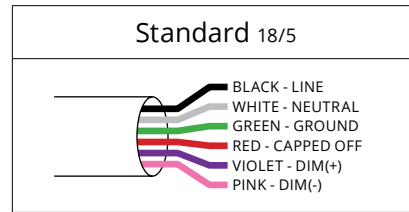

### SPECIFICATIONS

Due to the Continuous Improvement Policy at Metalumen, we reserve the right to change our specifications without notice.

**Housing:** Rigid extruded aluminum body, 2.0mm (0.08") nominal wall thickness. Aluminum formed end caps.  
**Optical System:** Metalumen luminaires are designed to utilize leading edge LED technology combined with luminaire optimized reflectors and our custom diffusers, resulting in industry leading optical performance.  
**CRI:** 83+ for 3500K, 80 minimum for all

CCTs in standard configurations.  
**Lumen Maintenance:** Minimum 50,000h with TM-21 lumen maintenance of 85% @ 25°C ambient temperature (calculated based on IESNA LM-80-08 LED test data). L70: ≥ 60 000hrs.  
**Finish:** Standard natatorium powder coated finish in satin aluminum, white and black. Exceeds 4000 salt spray hours (ASTM B117). For custom colors,

contact factory.  
**Weight:** 3 lb/ft  
**Mounting:** Wall vertical mount with lens facing out.  
**Drivers:** Metalumen offers dimming\* drivers as a standard on our entire LED product offering at 0-10V. Dimming range is 1%-100%. Power factor is > 90%. Class 2 rating. Drivers are integral. Consult factory for -40 drivers.

**Approvals:** All components are UL/ CSA/QPS recognized or listed. RoHS compliant. This product is cULus listed.  
**Environment:** Suitable for wet locations -22°F / -30°C start ambient temperature. Suitable for natatorium environments.

*\*Standard drivers compatible with passive/sinking dimmers. Please contact Metalumen if active/sourcing dimmer support is required.*

### WARRANTY

Metalumen will warrant defective luminaires for 5 years from date of purchase. Warranty is valid if luminaire is installed and used according to specification. If defective, Metalumen will send replacement boards or drivers at no cost along with detailed replacement instructions and instructions on how to return defective components to Metalumen.