

RAIL 6 WET S6W

RECESSED FLANGED . DIRECT

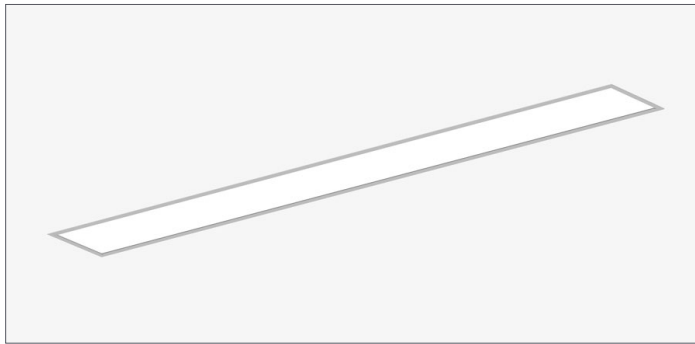

- Wet location and IP54 rated
- Continuous direct optics with no breaks
- Constructed of non-corrosive components
- Standard natatorium powder coat finish



PART #:		DATE:	
PREP BY:		QTY:	
PROJECT:		NOTES:	
APPROVAL SIGNATURE:		DATE (DD/MM/YYYY):	

PERFORMANCE SUMMARY @ 3500K		Meta Blanc (MB)
Lumens per foot	80 CRI	791
	90 CRI	692
Wattage per foot		8.6
Efficacy (LPW)	80 CRI	86
	90 CRI	80
L70 Estimate (h)		≥ 60,000 hrs

See page 2 for the complete Light Level Performance chart.

OTHER RAIL WET SERIES PRODUCTS



ORDERING LOGIC

Example Part Number: S6W-35K-8-MB-NW-1001-D-3-OO-90

S6W				MB				D			
1	2	3	4	5	6	7	8	9	10	11	12

1. SERIES	2. COLOR TEMP	3. LENGTH	4. PATTERN ¹	5. OPTICS	6. FINISH
S6W Direct	30K 3000K 35K 3500K 40K 4000K	3 3 ft 4 4 ft 5 5 ft 6 6 ft 7 7 ft 8 8 ft 9 9 ft 10 10 ft 11 11 ft 12 12 ft RA Continuous Rows (Replace "A" with length in feet) C Custom Length*	GA Square GAxB Rectangle UAxBxC U-Shape LAxB L-Shape C Custom Pattern* _ None (leave space empty) Standard Patterns Minimum Lengths Square: A=4 ft min., B=4 ft min. Rectangle: A=4 ft min., B=4 ft min. U-Shape: A=3 ft min., B=4 ft min., C=3 ft min. L-Shape: A=3 ft min., B=3 ft min. Custom Patterns* Lengths and a drawing of custom pattern are required on page 3 T-Shape, Cross/X, Wall-to-Ceiling Select corner: Outside 90° Inside 90° 	MB Meta Blanc Meta Blanc: Opal diffuse	NSA Satin Aluminum NW White NB Black NC Custom Specify RAL:
7. LIGHT LEVEL / DRIVER 35 350 lm/f 50 500 lm/f 75 750 lm/f 100 1000 lm/f C Custom Range. Specify lumens: (Total lumens between 350-1000 at 50 lm intervals) Select Driver below. See Light Level Performance chart on p2.	8. CIRCUITRY 1 1 Circuit EM Emergency / Night Light B Emergency Battery Pack* (remote mounted) (Limited to ambient temperatures down to 0°C)	9. MOUNTING D Recessed Drywall	10. VOLTAGE 1 120V 2 277V 3 347V 4 UNV (120 - 277V)	11. CONTROLS OO Outdoor Occupancy Sensor DD Outdoor Dusk to Dawn Sensor _ None (leave space empty)	12. OPTIONS 90 90 CRI, High R9 _ None (leave space empty)

*Consult factory. | ¹ Pattern record drawings showing mounting locations will be sent out upon order.

- Select Driver: Factory option 0-10V, 1% Dimming
 LHE Lutron H-Series Hi-lume 1% EcoSystem LED Driver
 LSE Lutron 5-Series EcoSystem LED Driver

Light Level Performance

3500K, 80 CRI, 0-10V Dimming

Light Level	Meta Blanc (MB)		
	Lumens per foot	Wattage per foot	Efficacy (LPW)
35	387	4.3	90
50	552	6.2	89
75	791	8.6	86
100	1010	12.3	82

Lumen Adjustment Factor

Color Temp	80 CRI	90 CRI
3000K	0.984	0.880
3500K	1.000	0.875
4000K	1.032	0.879

WIRING

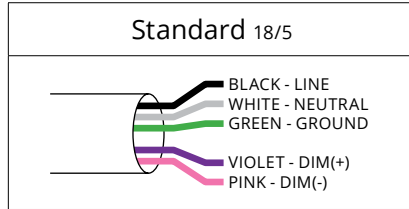

CROSS SECTION

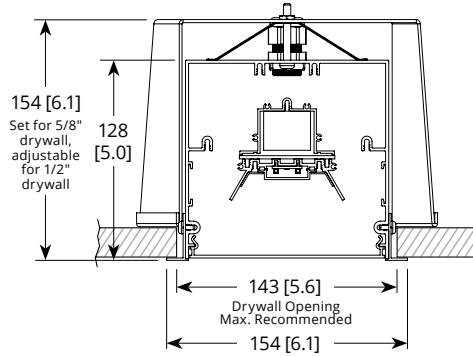

SPECIFICATIONS

Due to the Continuous Improvement Policy at Metalumen, we reserve the right to change our specifications without notice.

Housing: Rigid extruded aluminum body, 2.0mm (0.08") nominal wall thickness. Aluminum formed end caps.

Optical System: Metalumen luminaires are designed to utilize leading edge LED technology combined with luminaire optimized reflectors and our custom diffusers, resulting in industry leading optical performance.

CRI: 83+ for 3500K, 80 minimum for all

CCTs in standard configurations.

Lumen Maintenance: Minimum 50,000h with TM-21 lumen maintenance of 85% @ 25°C ambient temperature (calculated based on IESNA LM-80-08 LED test data). L70: ≥ 60 000hrs.

Finish: Standard natatorium powder coated finish in satin aluminum, white and black. For custom colors, contact factory.

Weight: 1.6 kg/300 mm [3.5 lb/ft]

Mounting: Mounting brackets provided.

Drivers: Metalumen offers dimming* drivers as a standard on our entire LED product offering at 0-10V. Dimming range is 1%-100%. Power factor is > 90%. Class 2 rating. Drivers are integral.

Approvals: All components are UL/CSA/QPS recognized or listed. RoHS



compliant. This product is cULus listed. **Environment:** Suitable for wet locations -22°F / -30°C start ambient temperature. Suitable for natatorium environments.

**Standard drivers compatible with passive/sinking dimmers. Please contact Metalumen if active/sourcing dimmer support is required.*

WARRANTY

Metalumen will warrant defective luminaires for 5 years from date of purchase. Warranty is valid if luminaire is installed and used according to specification. If defective, Metalumen will send replacement boards or drivers at no cost along with detailed replacement instructions and instructions on how to return defective components to Metalumen.

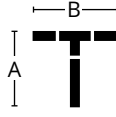
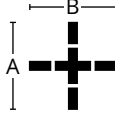
PATTERNS

Select Pattern:	<input type="checkbox"/> T-SHAPE (C)	<input type="checkbox"/> CROSS / X-SHAPE (C)	<input type="checkbox"/> WALL-TO-CEILING (C)
Pattern Configuration			
Indicate Desired Lengths (ft)	Consult Factory		
Minimum Lengths	A = 3 ft B = 6 ft	A = 6 ft B = 6 ft	A = 3 ft B = 3 ft

A custom pattern configuration drawing is required in the grid below

Approval drawings will be sent out upon order showing mounting locations.



PHOTOMETRIC DATA - 3500K, 80 CRI

Optics: **Meta Blanc**
 IES File: **S6W-35K-4-MB-75**
 Lumens: **791/ft** Wattage: **8.1/ft**
 Efficacy: **86 LPW**

ZONAL LUMEN SUMMARY

Zone	Lumens	%Fixt
0-90	3164	100
90-180	0	0
0-180	3164	100

LUMINANCE DATA (CD/M2)

Vertical Angle	Horizontal Angle	
	0/180	90/270
85	3994	5123
75	5180	5098
65	5801	5792
55	6243	6240
45	6622	6667

PHOTOMETRIC CURVE
100% Down

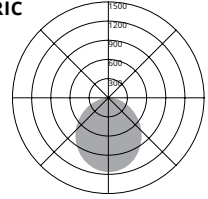

Photometric performance is measured and scaled in accordance with IESNA LM-79.