

# RAIL 2 WET S2WD

SURFACE . DIRECT

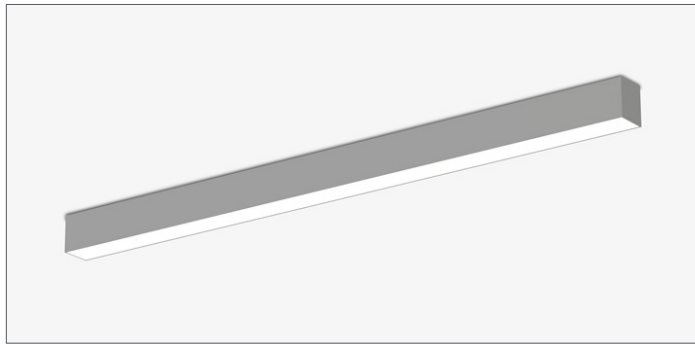

- 2.4 inch wide profile
- Continuous direct optics with no breaks
- Constructed of corrosion resistant components
- Standard natatorium powder coat finish



PART #:	
PREP BY:	DATE:
PROJECT:	QTY:
NOTES:	
APPROVAL SIGNATURE:	DATE (DD/MM/YYYY):

PERFORMANCE SUMMARY @ 3000K, 90CRI	Meta Blanc (MB)
Light Level	<b>27</b>
Lumens per foot	342
Wattage per foot	3.3
Efficacy	83
L70 Estimate (h)	≥ 60,000 hrs

See complete Light Level Performance on next page.

## OTHER RAIL WET SERIES PRODUCTS

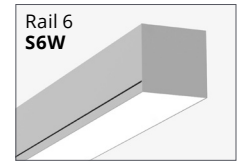
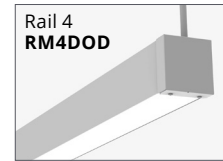
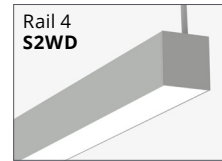

## ORDERING LOGIC

Example Part Number: S2WD-35K-8-MB-NW-901-S-4-90

<b>S2WD</b>								<b>S</b>			<b>90</b>
1	2	3	4	5	6	7	8	9	10	11	12

1. SERIES	2. COLOR TEMP	3. LENGTH	4. PATTERN <sup>1</sup>	5. OPTICS	6. NATATORIUM FINISH
<b>S2WD</b> Direct	<b>30K</b> 3000K <b>35K</b> 3500K <b>40K</b> 4000K	<b>2</b> 2 ft <b>3</b> 3 ft <b>4</b> 4 ft <b>5</b> 5 ft <b>6</b> 6 ft <b>7</b> 7 ft <b>8</b> 8 ft <b>9</b> 9 ft <b>10</b> 10 ft <b>11</b> 11 ft <b>12</b> 12 ft <b>RA</b> Continuous Rows (Replace "A" with length in feet) <b>C</b> Custom Length*	<b>GA</b> Square <b>GAxB</b> Rectangle <b>UAxBxC</b> U-Shape <b>LAxB</b> L-Shape <b>C</b> Custom Pattern* _ None (leave space empty)  Standard Patterns Minimum Lengths  Square: A=4 ft min., B=4 ft min. Rectangle: A=3 ft min., B=4 ft min., C=3 ft min. U-Shape: A=3 ft min., B=4 ft min., C=3 ft min. L-Shape: A=3 ft min., B=3 ft min.  Custom Patterns*  T-Shape    Cross/X    Wall-to-Ceiling	<b>MB</b> Meta Blanc  <b>MB:</b> Acrylic opal diffuse lens  See Photometric Data on next page.	<b>NSA</b> Satin Aluminum <b>NW</b> White <b>NB</b> Black <b>NC</b> Custom Specify RAL:
<b>90</b> CRI is standard					
7. LIGHT LEVEL / DRIVER	8. CIRCUITRY	9. MOUNTING	10. VOLTAGE	11. CONTROLS	12. OPTIONS
<b>27</b> 270 lm/f <b>34</b> 340 lm/f <b>C</b> Custom Range. Specify lumens: (Total lumens between 270-800 at 50 lm intervals) Select Driver below. See Light Level Performance chart on next page.	<b>1</b> 1 Circuit <b>EM</b> Emergency / Night Light <b>B</b> Emergency Battery Pack (Remote for 2-3 ft lengths. Integral for 4 ft and longer.) (Limited to ambient temperatures down to 0°C.)	<b>S</b> Surface	<b>3</b> 347V <b>4</b> UNV (120 - 277V)	<b>_</b> None (leave space empty)	<b>_</b> None (leave space empty)

\*Consult factory. | <sup>1</sup> Pattern record drawings showing mounting locations will be sent out upon order.

Select Driver:  **FD** Factory options 0-10V, 1% Dimming  
 **D2** DALI  
Consult factory for -40 drivers.

## LIGHT LEVEL PERFORMANCE

### 3000K, 90CRI, 0-10V Dimming (Standard)

Light Level	Lumens per foot	Wattage per foot	Efficacy (LPW)	IES File	Distribution % (Down / Up)	Zonal Lumens (0-90 / 90-180)	Distribution Curve
27	275	3.3	83	S2WD-30K-4-MB-27	100/0	1100 / 0	
34	342	4.3	79	S2WD-30K-4-MB-34		1368 / 0	
45	455	5.8	78	S2WD-30K-4-MB-45		1824 / 0	
80	816	12.0	68	S2WD-30K-4-MB-80		3264 / 0	

Metalumen's light level performance metrics are subject to manufacturers component tolerances. Photometric performance is measured and scaled in accordance with IESNA LM-79.

### Lumen Adjustment Factor (Standard)

Color Temp	90 CRI
3000K	1.000
3500K	1.016
4000K	1.049

## CROSS SECTION

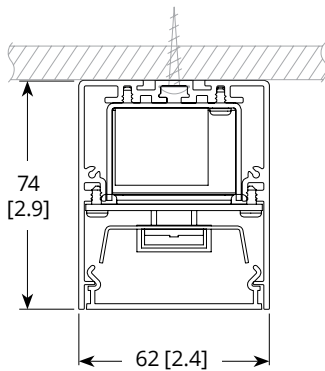

## WIRING

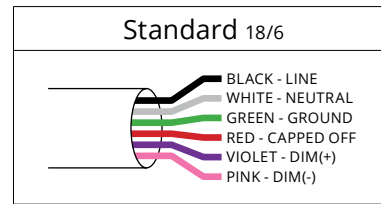

## POWER CABLE FEED LOCATION

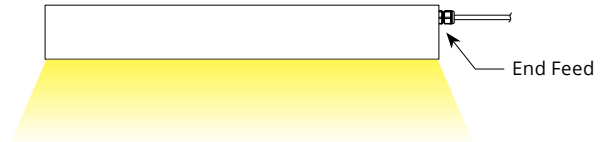

## SPECIFICATIONS

Due to the Continuous Improvement Policy at Metalumen, we reserve the right to change our specifications without notice.

**Housing:** Rigid extruded aluminum body, 2.0mm (0.08") nominal wall thickness. Aluminum formed end caps.  
**Optical System:** Metalumen luminaires are designed to utilize leading edge LED technology combined with luminaire optimized reflectors and our custom diffusers, resulting in industry leading optical performance.  
**CRI:** 83+ for 3500K, 80 minimum for all CCTs in standard configurations.

**Lumen Maintenance:** Minimum 50,000h with TM-21 lumen maintenance of 85% @ 25°C ambient temperature (calculated based on IESNA LM-80-08 LED test data). L70: ≥ 60 000hrs.  
**Finish:** Standard natatorium powder coated finish in satin aluminum, white and black. Exceeds 4000 salt spray hours (ASTM B117). For custom colors, contact factory.  
**Weight:** 2 lb/ft

**Mounting:** Surface ceiling mount. Hole on extrusion for screws (by others).  
**Drivers:** Metalumen offers dimming\* drivers as a standard on our entire LED product offering at 0-10V. Dimming range is 1%-100%. Power factor is > 90%. Class 2 rating. Drivers are integral. Consult factory for -40 drivers.  
**Approvals:** All components are UL/CSA/QPS recognized or listed. RoHS compliant. Pending cULus listing.

Pending IK10 rating. Electrical components are IP65 rated.  
**Environment:** Suitable for wet locations -22°F / -30°C start ambient temperature. Suitable for natatorium environments.

*\*Standard drivers compatible with passive/sinking dimmers. Please contact Metalumen if active/sourcing dimmer support is required.*

## WARRANTY

Metalumen will warrant defective luminaires for 5 years from date of purchase. Warranty is valid if luminaire is installed and used according to specification. If defective, Metalumen will send replacement boards or drivers at no cost along with detailed replacement instructions and instructions on how to return defective components to Metalumen.